

# *Sound and Vibration*



RION/Norsonic S&V Measuring Instruments General Catalog  
2024

# RION

## About general requirements for the competence of testing and calibration laboratories (ISO/IEC 17025)

RION Service Center CO., LTD. has earned certification under ISO/IEC 17025, an international standard on the ability of testing laboratories to generate accurate results. This makes us the first calibration service provider in Japan for manufacturers of sound level meters and sound calibrators to have earned this certification.\* ISO/IEC 17025 is a standard for certification by an independent certifying agency on the ability of testing and calibration laboratories to generate accurate measurements and calibration results. It establishes requirements for testing laboratories engaged in activities such as product testing, analysis, and measurement as well as calibration laboratories engaged in the business of calibrating measurement instruments. A certified laboratory is internationally certified to possess management competence in product control and quality control as well as technical competence in generating reliable testing and calibration results.

\* IEC 61672-3 (Electroacoustics - Sound level meters, Part 3: Periodic tests), the calibration method for sound level meters, and IEC 60942 (Electroacoustics - Sound calibrators, Annex B: Periodic tests), the calibration method for the sound calibrators used to calibrate such sound level meters

### Designated models

|                    |  |
|--------------------|--|
| Sound Level Meters | NL-43, NL-53, NL-63, NL-42A, NL-52A, NL-62A, NL-42, NL-52, NL-62, NL-27, NA-28 |
| Pistonphone        | NC-72A, NC-72B   |
| Sound Calibrators  | NC-74, NC-75   |

## About the JCSS Calibration Certificate

The Quality Assurance Section of RION CO., LTD. has gained accreditation by the JCSS (Japan Calibration Service System) as an MRA (Mutual Recognition Arrangement) compliant operator in the category of Acoustics & Ultrasound, Acceleration Measuring Instruments (accreditation number JCSS 0197). JCSS is operated by the accreditation body (IA Japan) which is a signatory to the Asia Pacific Accreditation Cooperation (APAC) as well as the International Laboratory Accreditation Cooperation (ILAC). Being recognized as an international MRA compliant JCSS operator means that RION can issue calibration certificates bearing the ILAC MRA compliant JCSS symbol for acoustics & acceleration measuring instruments (sound level meters, measurement microphones, sound calibrators, accelerometer). Calibration certificates with the ILAC MRA compliant JCSS symbol are recognized throughout the world.

### JCSS Compliant Acoustic Measuring Instruments

■ Sound Level Meters ■ Measurement Microphones ■ Sound Calibrators ■ Reference Piezoelectric Accelerometers



**JCSS**  
JCSS 0197

RION CO., LTD. is recognized by the JCSS which uses ISO/IEC 17025 as an accreditation standard and bases its accreditation scheme on ISO/IEC 17011. JCSS is operated by the accreditation body (IA Japan) which is a signatory to the Asia Pacific Accreditation Cooperation (APAC) as well as the International Laboratory Accreditation Cooperation (ILAC). The Quality Assurance Section of RION CO., LTD. is an international MRA compliant JCSS operator with the accreditation number JCSS 0197.

### Designated models

|  |   |
|--|---|
| Sound Level Meters                               | NL-43, NL-53, NL-63, NL-42A, NL-52A, NL-62A, NL-42, NL-52, NL-62, NL-20, NL-21, NL-22, NL-31, NL-32, NL-26, NL-27, NL-28, NA-28, NA-42S |
| Measurement Microphones                          | UC-30, UC-31, UC-52, UC-53A, UC-57, UC-59   |
| Pistonphone                                      | NC-72, NC-72A, NC-72B   |
| Sound Calibrators                                | NC-74, NC-75  |
| Reference Piezoelectric Accelerometers           | PV-03   |
| Piezoelectric Accelerometers                     | PV-65, PV-85, PV-86, PV-90H   |
| Field Vibration Calibrator (CALIBRATION EXCITER) | VE-10   |

## ISO Certification

### ISO 14001 certification

In 1999, RION CO., LTD. obtained ISO 14001 certification for its environment management system, and is keeping the certification current (ISO 14001: 2015).

### ISO 9001 certification

In 1993, RION CO., LTD. obtained ISO 9001 certification for its quality management system, and is keeping the certification current (ISO 9001: 2015).

## Designated Manufacturer According to the Japan Measurement Act

RION CO., LTD. is a designated manufacturer according to the Japan Measurement Act, category for special measurement instrument (sound level meters and vibration level meters). A designated manufacturer is officially recognized as having excellent manufacturing facilities as well as effective quality control systems. Such a manufacturer is allowed to carry out product verification corresponding to national certification verification, based on the Japan Measurement Act verification regulations. Products which pass such a verification receive a seal that certifies compliance with the required standards. The seal has the same legal status as an official verification mark, and means that the measurement device can be used for commercial transactions and authentication.

### Designation dates and designation numbers

- Sound level meters Designation date: May 13, 1998, Designation number: 341301
- Vibration level meters Designation date: March 6, 2000, Designation number: 351301

# INDEX

■ RION Green Products .....P4 to 5

## Acoustics

- Sound Analyser/NorCloud..... 6 to 7
- Sound Level Meter .....P8 to 10
- Noise Dosimeter ..... P11
- RION-Environmental Managing System.....P12 to 13
- Measurement System / Tapping Machine /  
Impact Ball / Heavy Floor Impact Source /  
Dodecahedron Loudspeaker / Power Amplifier /  
Microphone Boom / Reference Sound Source.....P14 to 15
- Acoustic Camera / Impedance Tube /  
Anechoic Box / Anechoic Room /  
Sound Proof Chamber .....P16 to 17
- Measurement Microphone / Pre-amplifier .....P18
- Measuring Amplifier / Sound Level Meter Unit /  
Optional accessories (For Sound Level Measurement) .....P19
- Measurement Microphone Combination Examples .....P20
- Sound Level Meter Connection Examples .....P21

## Vibration

- Piezoelectric Accelerometers .....P22
- Servo Accelerometer etc. ....P23
- Tri-axial Groundborne Vibration Meter .....P24
- Vibration Level Meter .....P25
- 3-Axis Vibration Meter / Vibration Monitor.....P26 to 27
- General-Purpose Vibration Meter ..... P28
- Vibration Analyzer .....P29
- Vibration Meter Unit /  
2-Channel Charge Amplifier /  
General-Purpose Vibration Meter .....P30 to 31
- Accelerometer Selection .....P32
- Vibration Meter Connection Examples .....P33

## Frequency Analysis

- Multi-Channel Signal Analyzer / Software /  
System .....P34 to 39
- Sound and Vibration Evaluation System .....P40 to 41
- Portable Multi-function Measuring System .....P42 to 43

## Recording

- Data Recorder / Software ..... P44 to 45
- Level Recorder ..... P45

## Related Products

- Viscometer / Acoustical Volumeter ..... P46 to 47

External view drawings of measurement  
microphone and accelerometer cables ..... P48

## Measuring Instrument Combinations

..... P49 to 56

## Outline

- Noise and Sound Level Meters ..... P57
- Vibration and Vibration Meters ..... P58
- Frequency and Frequency Analyzers ..... P59
- Recording Sound and Vibration ..... P60

## Knowledge in a Nutshell

..... P61

## Company Outline

- RION CO., LTD. .... P62
- Norsonic ..... P63
- Other services offered by RION Group ..... P64
- Kobayasi Institute of Physical Research ..... P65

## INDEX

- INDEX (Model) ..... P66
- INDEX (Name) ..... P67

# RION Green Products

With the aim of creating truly environment friendly products, RION has established the "RION Green Procurement Guidelines". We use them as a standard for product development and parts procurement, to ensure that we can offer products that do not contain any harmful or hazardous chemical substances.



## class 1 / class 2 Sound Level Meters NL-43/53/63

Equipped with LAN terminals to enhance connectivity with other devices. The USB Type-C terminal allows power supply from mobile batteries compatible with USB Type-C connections. Buttons on the unit and the large, easily readable 3.5-inch color touch panel LCD ensures ease of use. These models offer functions for measuring A-weighted sound pressure levels, equivalent continuous A-weighted sound pressure levels, and minimum and maximum sound pressure levels, as well as percentile and sound exposure levels. Measurement data can be saved/written to internal memory or an SD card. The single range format eliminates the need to select and switch between ranges during measurements. The display interface offers multiple language options. In addition to the LAN and USB terminals, the unit is equipped with AC output, DC output, and RS-232C terminals. The water resistance performance of the main unit meets IP54 specifications (excluding the microphone) for use outdoors. The models can also run on AA alkaline batteries or Ni-MH batteries. The NL-63 can measure both ultra-low frequency (1 Hz–20 kHz) and audible frequency sound pressure levels.

## Class 2 Sound Level Meter NL-28

Easy to use with one hand! The non-slip design makes it easy to grip. Allows  $L_p$ ,  $L_{eq}$ ,  $L_E$ , and  $L_{max}$  measurement. Convenient for sound calibration before and after measurement. Insert the microphone into the acoustic calibrator and calibration is performed automatically. By connecting the USB Type-C connector and PC with a cable, data measured with the NL-28 can be acquired as a CSV file.



## Noise Dosimeter NB-14

The NB-14 noise dosimeter, measures noise exposure for an individual working in a noisy workplace. Measuring and managing noise exposure for individual workers enable early detection and treatment of noise-induced hearing impairment, the adoption of personal hearing protection equipment such as earplugs and earmuffs, and the introduction of effective measures to reduce noise at the source.



## Aircraft Noise Monitoring System NA-39A

This system is designed for automated monitoring of aircraft noise. It is capable of calculating evaluation values according to the "Environmental Standard Related to Aircraft Noise". Improved aircraft identification supports long-term measurement and generates more accurate data. Compact and lightweight design facilitates installation. Power consumption reduced by about fifty percent.



## Sound Level Meter Unit UN-14

Designed for linked use in a measurement system for sound and vibrations, supporting flexible configuration. Integrated A, C, and Z weighting characteristics. AC and DC outputs allow connection of level recorder or analyzer.



## Pistonphone NC-72B

Suitable for IEC 60942: 2017 class LS/M and class 1/M, JIS C 1515: 2020 class LS/M and class 1/M. Calibration sound source outputs 250 Hz tone at 114 dB SPL.



## Sound Calibrator NC-75

Conforming with IEC 60942: 2017 class 1 and JIS C 1515: 2020 class 1. Supports 1-inch, 1/2-inch, and 1/4-inch microphones. (1/4 inch with optional adapter)



## Multi-Channel Signal Analyzers SA-02M (4-channel expandable type) SA-02A4 (4-channel fixed type)



Frequency analyzers providing both FFT analysis capability and 1/1, 1/3, 1/12 octave band analysis capability. Allow direct sensor connection with TEDS support. Designed for easy operation. Wide range of optional software available.



## Portable Multi-function Measuring System RIONOTE

Consists of the Main Control Unit and two types of sensor amp units. In combination with analysis programs and a wireless dock, the system adapts to a wide variety of measurements, including remote measuring applications. A choice of input and output connectors enables easy system expansion, and the large-format color touch panel display makes operation simple and intuitive. Various types of analysis programs will be released progressively.

### Vibration Meter Unit UV-15

Suitable for a wide range of vibration measurements. Three types of input connectors and AC and DC outputs are provided. Integrator converts vibration acceleration signal into vibration displacement signal. Display readings for three detection types.



### 2-Channel Charge Amplifier UV-16

Input connectors and AC output connectors for two channels. Linked use of several units allows multi-channel configuration. Integrator converts vibration acceleration signal into vibration displacement signal. Other features include high-pass filter, low-pass filter, and integrated oscillator for calibration of a level recorder or frequency analyzer.



### Vibration Analyzer VA-12

Vibration meter with FFT analysis function. Designed for hand-held use in the field, for example to perform equipment diagnosis. Color TFT display provides excellent readability, and convenient Japanese-language or English-language menus can be used for measurement. Sampling frequency 51.2 kHz. 24 bit A/D conversion provides dynamic range of up to 110 dB. Equipped with USB port and SD card slot.



### 4 channel Data Recorder DA-21

Capable of recording acoustic or vibration waveforms and various voltage signals in the field. Data are saved on memory card in WAVE format, and analog playback is supported. Directly importing data into a computer for waveform analysis processing is also possible.



### General-Purpose Vibration Meter VM-83

Measure and evaluate vibrations using a piezoelectric accelerometer or servo accelerometer. With the servo accelerometer, even very low frequency vibrations from 0.1 Hz upwards can be measured. Measurement items are acceleration, velocity, and displacement.



### Piezoelectric Accelerometers PV Series



Covering a broad range of applications, these accelerometers are available in many sizes and configurations, ranging from an ultra-compact unit weighing only 0.7 grams to high output and high sensitivity types, as well as accelerometers with high temperature resistance for nuclear power plant use, 3-axis types, integrated amplifier types, and more.

### Viscometer VT-06

0.3 to 4 000 dPa·s

Rotary type viscometer using resistance to rotor movement caused by viscosity (torque) to obtain readings. Designed for quality control applications in manufacturing of industrial products such as petrochemicals, paint, and adhesives, as well as foodstuffs.



# Acoustics

Large colour touchscreen, intuitive menus – easy to use.

## Single channel Sound Analyser

Nor145 

## Dual channel Sound Analyser

Nor150 

The Nor145 and Nor150 sound analysers sets new standards in userfriendliness and sophistication not yet found in any other sound level meter on the market today. Featuring a large 4.3" true colour touchscreen sharing the same user philosophy as a smartphone.

### Features

- Precision sound level meter and frequency analyser according to class 1
- Easy connectivity via built in WLAN and 3G/4G LTE modem (Nor145)
- Dual channel (Nor150 only)
- Large colour touch-screen (4.3")
- Real push keys for quick operation in challenging environments
- Intuitive user interface with graphical icons for selection of measurement mode and custom-made user setups
- Built-in webserver
- Voice, text notes and built-in GPS for documentation of the measurements
- Wide frequency range (0,4 Hz – 20 kHz in 1/3 octave band)
- Parallel 1/3 octaves and FFT analysis
- 120 dB measurement range
- Extensive trigger system for reports, audio recording and camera
- Seamless integration with Nor850 software
- Easy management of measurement files in NorConnect Nor1051
- Multi-language support
- Extensive on-board help system



## Environmental Analyser

Both units are ideal for all type of environmental noise measurements, attended or unattended, single or dual channel measurements. The Nor145 with its built in 4G/LTE modem features an easy connectivity to NorCloud and are for most environmental applications a preferred choice due to its built-in modem.



### Applications

- Sound Power measurements in accordance with -ISO 9614 -ANSI S12.12 -ECMA 160
- Noise Mapping
- Noise Source locations



## Sound Intensity Analyser Nor150

The Nor150 fitted with sound intensity option and the sound intensity probe kit Nor1290 is a powerful tool for all kind of sound intensity measurements. It is designed for easy use in all type of measurement conditions. The remote-control handle using a Smartphone as a measurement control and displaying device forms a light weighted and easy to use system, allowing the user to perform all measurements with a single hand operation. The Smartphone communicates via Wi-Fi with the internal web server running in the Nor150. The system may also be used with the sound intensity probe directly attached to the Nor150.



### Supported Standards

- ISO 16283-1, -2 and -3.
- ISO 140-4, -5 and -7,
- ISO 717-1 and -2, ISO 10052
- ASTM E336 and E413, ASTM E1007 and E989
- DIN 4109-4 and -11
- BS-ISO 140-4 and -7
- SS-EN-ISO 25267
- SIA 181



## Building Acoustic Analyser

It can be used as a manually operated single or dual channel (Nor150) building acoustic analyser, or as a remotely controlled advanced building acoustic frontend for the Nor850 multichannel system. The Building Acoustics mode is designed to cover any in-situ sound insulation measurement tasks. You may choose to measure airborne, façade or impact sound insulation.

## Noise at Work Analyser

The Nor145 is the right tool for the noise at work experts. It covers all the use in one unit. The wide frequency range covers additional applications such as infra sound and single axis vibration measurements.

## NorVirtual/NorVirtual App

NorVirtual for Nor145/No150 supports all communication channels. Hence, you may connect to a Nor145/Nor150 via modem, Wlan, LAN etc and use the program as a simple remote control.

In combination with NorConnect you have a simple and intuitive solution for remote control and download measurements.

NorVirtual App can be downloaded from Apple Store or Google Play.



## NorConnect Nor1051

NorConnect is a measurement suite and data management program for measurement files downloaded from Nor145 and Nor150. Dependent of your measurement, optimized graphical tools are offered for building acoustic, sound power and environmental/general measurements.



## NorReview Nor1026

The NorReview is a flexible project oriented PC software package for presenting and post processing environmental noise data from our instruments.



## NorCloud - Noise monitoring made easy!

NorCloud is designed to fit your need for noise monitoring. Even if you are a non expert, NorCloud offers you an easy setup of a project with alarms and triggers. Assigning your sound level meter or sound monitoring station has never been easier; connect the instrument to Internet, register the sensors id number in your NorCloud project, and you are up and running. Once registered the same sensor can easily be moved between your projects when needed. A powerful report generator integrated in NorCloud offers you to design your own report templates (or you can use

one of our standard templates). You can set NorCloud to distribute via e-mail as many measurement reports that you need, as often as you want. Or just select a time window in the graph, and generate a NorCloud report based on the selected time span. Our Noise Monitoring Terminal Nor1531 is a weather proof cabinet supplied as a ready to go unit, including a IEC 61672 class 1 compliant instrument, our famous all weather outdoor microphone Nor1216, battery for shorter disruptions in power supply and a 4G modem.

### When is NorCloud the preferred solution?

## Whenever and wherever you need to monitor and collect noise data on a permanent or a longer time span as in:



- Construction noise monitoring
- Transport noise monitoring
- City noise monitoring
- Industrial estate noise monitoring
- Airport noise monitoring
- Harbour noise monitoring
- Race track and Shooting range monitoring
- Outdoor concerts and venues

NorCloud is seamless integrated with NorReview, when further analysis of measurement data is needed. Just select the periode window of interest, download the measurement and open it in NorReview. The NorReview PC software package is one of the most powerful tool available for post processing and presentation of environmental noise data. NorCloud is available in English, German, French and Spanish.

### Why Norcloud?

## Fast, easy to connect your sensor to NorCloud via 4G, Wi-Fi or LAN.

- No software installation required.
- All data automatically uploaded to NorCloud.
- Access all your data with any web browser on any device. The site is smart phone compatible.
- Project management with measurement, trigger and alert setups, in addition to user access control.
- Powerful report designer and generator integrated.
- View live data or download time specific measurements on the go.
- Seamless integrated with NorReview.
- Real time SMS and e-mail alerts sent directly from instrument.
- Protect your data. Redundant storage of data locally on the unit and in NorCloud.
- Norsonic reliability.



# Acoustics

## Exploring the possibility of Noise Measurement

Designated manufacturer of special measurement instrument  
Designation number : 341301 (The Japan Measurement Act)



### Class 1 Sound Level Meter NL-63

(With low-frequency sound measurement function)

### Class 1 Sound Level Meter NL-53

### Class 2 Sound Level Meter NL-43



NL-53

NL-43

NL-63

- Equipped with LAN terminals to enhance connectivity with other devices.
- Power can be supplied from portable charger via the USB Type-C connector.
- A single sound level meter can measure up to four measurement conditions simultaneously. Different frequency weighting and time weighting settings can be specified for each of four measurement conditions.
- The color touch panel LCD has been designed to offer high visibility both indoors and outdoors, and in the dark.

| Specifications                           | Class 1 Sound Level Meter<br>(With low-frequency sound measurement function)<br><b>NL-63</b>   | Class 1 Sound Level Meter<br><b>NL-53</b>  | Class 2 Sound Level Meter<br><b>NL-43</b>   |
|--|--|--|---|
| Applicable standards                     | IEC 61672-1: 2013 class 1, ISO 7196: 1995, ANSI/ASA S1.4-2014/Part1 class 1, JIS C 1509-1:2017 class 1, JIS C 1516: 2020 class 1, ISO 7196: 1995<br>CE marking *EMC Directive Directive 2014/30/EU EN 61326-1:2013 *RoHS Directive Directive 2011/65/EU EN IEC 63000:2018 *Low Voltage Directive Directive 2014/35/EU EN 61010-1:2010/A1:2019, UKCA Marking, China RoHS, KC mark, VCCI Class B | IEC 61672-1: 2013 class 1, ANSI/ASA S1.4-2014/Part1 class 1, JIS C 1509-1: 2017 class 1, JIS C 1516: 2020 class 1  | IEC 61672-1: 2013 class 2, ANSI/ASA S1.4-2014/Part1 class 2, JIS C 1509-1: 2017 class 2, JIS C 1516: 2020 class 2 |
| Measurement function                     | Simultaneous measurement of up to four conditions (Main channel, Sub1 to Sub3 channels) with selected time weighting and frequency weighting   |  |   |
| Measurement function                     | Instantaneous value<br>Time-weighted sound pressure level $L_p$  |  |   |
|  | Calculated value<br>Equivalent continuous sound level: $L_{eq}$ , I-time-weighted equivalent continuous sound level: $L_{eq}^{*2}$ , Moving $L_{eq}$ : $L_{eq, mov}^{*2}$ , Sound exposure level: $L_E$ , Maximum sound level: $L_{max}$ , Minimum sound level: $L_{min}$ , Percentile sound level: $L_N$ , Peak sound level: $L_{peak}$ , Takt-max sound level: $L_{tm5}$                     |  |   |
| Measurement level range                  | A-weighting: 25 dB to 138 dB, C-weighting: 33 dB to 138 dB, G-weighting: 43 dB to 138 dB, Z-weighting: 50 dB to 138 dB, C-weighted peak sound level: 60 dB to 141 dB, Z-weighted peak sound level: 65 dB to 141 dB   | A-weighting: 25 dB to 138 dB, C-weighting: 33 dB to 138 dB, Z-weighting: 38 dB to 138 dB, C-weighted peak sound level: 55 dB to 141 dB, Z-weighted peak sound level: 60 dB to 141 dB |   |
| Measurement frequency range              | 1 Hz to 20 kHz   | 10 Hz to 20 kHz  | 20 Hz to 8 kHz  |
| Frequency weighting                      | A, C, G, Z   | A, C, Z  |   |
| Time weighting                           | F (Fast), S (Slow), I (Impulse), 10 s  | F (Fast), S (Slow), I (Impulse)*2  |   |
| Power supply                             | 4 x AA batteries, power supply to DC jack and USB port   |  |   |
| Operating time<br>(at 23°C, ECO setting) | Alkaline battery LR6: Approx. 12 hours, Ni-MH rechargeable battery HR6: Approx. 12 hours, Portable charger: Approx. 20 hours of power at 5000 mAh<br>*When making Auto store mode and ECO settings, The operating time varies depending on the device settings and the battery manufacturer  |  |   |
|  | Alkaline battery LR6: Approx. 16 hours, Ni-MH rechargeable battery HR6: Approx. 16 hours, Portable charger: Approx. 24 hours of power at 5000 mAh<br>*When making Auto store mode and ECO settings, The operating time varies depending on the device settings and the battery manufacturer  |  |   |
| Languages                                | Japanese, English, German, Spanish, French, Chinese, Korean  |  |   |

\*1 Use Rion fully guaranteed products.  
\*2 NX-43EX required for NL-43/NL-53 (sold separately)

#### Precautions on portable charger usage

Avoid portable charger with functions that monitor device power consumption and are capable of interrupting the power supply. The power consumption of NL-43/53/63 is relatively low compared to smartphones; portable charger equipped with such features may erroneously terminate power supply to the unit.

### Intuitive operation without the need to refer to manual

#### Color LCD with touch panel



Measurement display  
(instantaneous SPL, 2 channels)

Measurement display  
(calculated values)

Measurement display  
(Time-Level Graph)

### Convenient for noise and low frequency sound measurements

A-weighted, G-weighted\*, and Z-weighted (LPF 100 Hz\*) sounds can be saved in a single measurement run. E.g.) Set with LAF, LGS, LZS (LPF100 Hz)

\*Only with NL-63

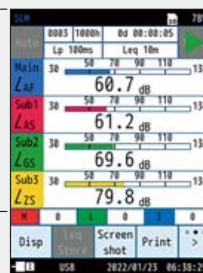

#### New Feature

A single meter can measure with up to 4 different settings simultaneously and reduces measurement time

You can set 4 different frequency and time weighting and save instantaneous and calculated values.

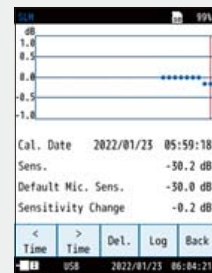

#### New Feature

View and manage a unit's calibration history and save to SD card

Recording changes in microphone sensitivity leads to reliable data management.



## Web browser

\*NX-43EX required for NL-43/NL-53

By connecting to a network, remote connection via web browser of PC or smartphone is established.

- View and acquire measurement date
- Remote operation of the sound level meter (measurement settings, start and stop of measurement, time adjustment, etc.)
- Real-time audio playback (with optional NX-43WR, Supported by only Google Chrome)
- File download (Downloads are limited to one file at a time.)
- Marker function (up to four colors)

## Marker function

Sections of characteristic sounds can be color-marked for later examination.

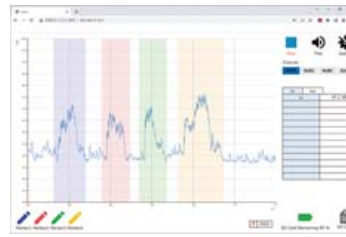

Measurement screen (Time-Level graph display, calculated value display)

## Case 1

### Environmental noise monitoring of remote locations

The operational status of the sound level meter can be checked remotely from a web browser, reducing the number of site visits. You can also use the meter with a mobile router for wireless communications.

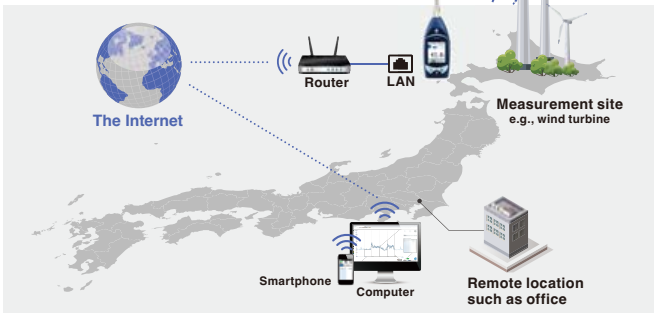

## Case 2

### Noise monitoring of equipment and machinery at factories and site boundary lines

Connecting the LAN terminal on the sound level meter and computer with a LAN cable allows noise monitoring from the web browser.

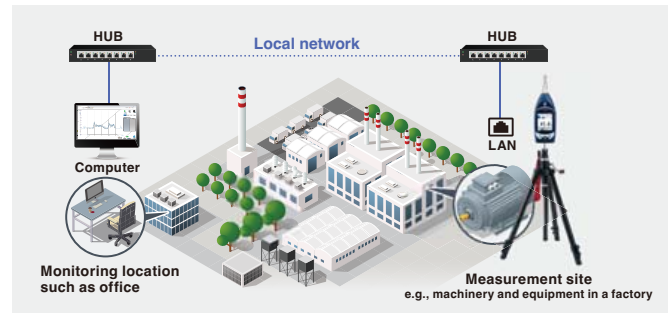

\*A NX-43WR is required to listen to the sound during noise measurement on your browser.

Adds a number of programs.

## Extended Function Program NX-43EX

Installation of NX-43EX\* enables addition of NX-43WR / NX-43RT / NX-43FT

\*The NX-43EX program cannot be uninstalled.  
\*The NX-43EX is pre-installed to NL-63

- Auto store function (instantaneous value, processed value)
- Instantaneous value's interval ( $L_p$  store interval) is Off, 10 ms, 25 ms, 100 ms, 200 ms, 1 s
- Comparator function
- Continuous data output function
- Trigger function
- LAN function
- Four types of marker functions

NX-43EX →

+

NX-43WR →

NX-43RT →

NX-43FT →



## Waveform Recording Program NX-43WR

- This function enables users to record sounds and to process sound levels simultaneously.
- Recorded data can be played on computer and used for frequency analysis. (Uncompressed waveform WAVE file)

\* For NL-63 only

- Sampling at 48 kHz, 24 kHz, 12 kHz, 1200Hz\*, 240Hz\*
- Selection of 24 bit or 16 bit

Maximum recording time (Assumes certain settings for auto store mode, 16 bit, and  $L_p$  store cycle of 100 ms:)

\* For NL-63 only

| Sampling frequency | Memory card | 512 MB | 2 GB  | 32 GB  |
|--------------------|-------------|--------|-------|--------|
| 48 kHz             |             | 1 h    | 4 h   | 74 h   |
| 24 kHz             |             | 2 h    | 9 h   | 146 h  |
| 12 kHz             |             | 4 h    | 18 h  | 278 h  |
| 1200 Hz*           |             | 24 h   | 100 h | 1520 h |
| 240 Hz*            |             | 41 h   | 165 h | 2520 h |

Recording in 24 bit creates files 1.5 times larger than 16-bit recordings. Accordingly, the maximum recording time is reduced to 2/3.

## Octave, 1/3 Octave Real-time Analysis Program NX-43RT

### NX-43RT

### NX-63RT

(Compatible with NL-63)

- Octave band and 1/3 octave band analysis can be performed.

Examples of the display screen

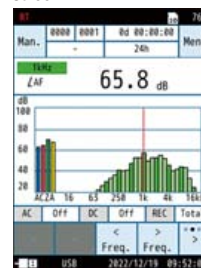

1/3 octave band analysis display

## FFT Analysis Program NX-43FT

- FFT analysis can be performed.

Examples of the display screen

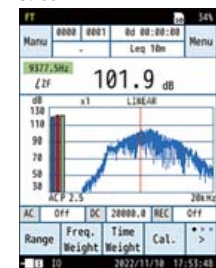

Analysis display (x1)

## Complete software for environmental measurements

### Data Management Software for Environmental Measurement AS-60

#### AS-60RT (Includes octave and 1/3 octave data management software)

Enables measurement data graph display, arithmetic processing, sound exclusion, report creation, file output, and real-sound file playback. AS-60RT adds support for handling octave band analysis data to AS-60.

- If AS-60/60RT/60VM is used on the NL-42A/52A/42/52, the NX-42EX is also needed.
- If AS-60/60RT/60VM is used on the NL-43/53, the NX-43EX is also needed.

Supported models

AS-60  
 ■ NL-43/53/63\* ■ NL-42A/52A/62A\* ■ NL-42/52/62\*  
 ■ NL-21/22/31/32\* ■ DA-40 Viewer

AS-60RT  
 ■ NX-43RT/63RT\* ■ NX-42RT/62RT\*  
 ■ NA-28\* ■ SX-A1RT\*

\*Only auto store data are supported.



Data management screen (AS-60)



Data management screen (AS-60RT)

# Acoustics

**High-quality and cost-effective. Essential functions.  
Complies with IEC standards.**

## Class 2 Sound Level Meter NL-28



**Easy to use with one hand.  
The non-slip design makes it easy to grip.  
Button layout provides intuitive operability.**

- Comforms to IEC 61672-1:2013 class 2, JIS C 1509-1:2017 class 2, JIS C 1516:2020 class 2
- Pause measurement function to remove unwanted noises for measurement evaluation.
- Continuous operation time is over 9 hours with two AA batteries (Compatible with alkaline batteries, Ni-MH rechargeable batteries)

At the selected time weighting, the following calculation values can be measured simultaneously.

| Measurement function                        | A-weighting | C-weighting |
|---|-------------|-------------|
| Time-weighted sound level $L_p$             | ●           | ●           |
| Equivalent continuous sound level $L_{eq}$  | ●           | ●           |
| Maximum time-weighted sound level $L_{max}$ | ●           | ●           |
| Sound exposure level $L_E$                  | ●           | ●           |
| Peak sound level $L_{peak}$                 | —           | ●           |

### Useful for:

Occupational safety and health, construction, traffic, karaoke/bars, factories, schools, hospitals, car inspections, HVAC, etc.

### Easy-to-read OLED display



### Equipped with USB Type-C connector



By connecting the USB Type-C connector and PC with a cable, data measured with the NL-28 can be acquired as a CSV file.

### Specifications

|                                       |  |
|---------------------------------------|--|
| Applicable standards                  | IEC 61672-1:2013 class 2<br>JIS C 1509-1:2017 class 2<br>JIS C 1516:2020 class 2<br>CE Marking<br>• EMC Directive Directive 2014/30/EU EN 61326-1:2013<br>• RoHS Directive Directive 2011/65/EU EN IEC 63000:2018<br>UKCA Marking, China RoHS, KC Mark |
| Measurement function                  | At the selected time weighting, the following calculation values can all be measured simultaneously at the frequency weighting A and C. (For $L_{peak}$ , only the C-weighting can be measured.)   |
| Instantaneous value                   | Time-weighted sound level $L_p$  |
| Calculated values                     | Equivalent continuous sound level $L_{eq}$<br>Sound exposure level $L_E$<br>Maximum time-weighted sound level $L_{max}$<br>Peak sound level $L_{peak}$   |
| Measurement level range               | A-weighting: 30 dB to 137 dB, C-weighting: 36 dB to 137 dB,<br>C-weighted peak sound level: 65 dB to 140 dB  |
| Measurement frequency range           | 20 Hz to 8 kHz   |
| Power supply                          | AA battery × 2   |
| Operating time (23 °C at measurement) | Alkaline battery: Approx. 9 hours,<br>Ni-MH rechargeable battery: Approx. 9 hours  |
| Dimensions, weight                    | Approx. 200 mm (H) × 50 mm (W) × 34 mm (D),<br>Approx. 160 g (including batteries)   |
| Optional accessories                  | Sound calibrator NC-75, Pistonphone NC-72B,<br>Tripod for sound level meter ST-80  |

### Automatic calibration function

- Convenient for sound calibration before and after measurement. Insert the microphone into the acoustic calibrator and calibration is performed automatically.
- Calibration history data can be stored.

Sound Calibrator  
NC-75



## Workplace Noise Measurements for Industrial Safety and Health

### Noise Dosimeter NB-14



- The NB-14 noise dosimeter, measures noise exposure for an individual working in a noisy workplace. It enables early detection and treatment of noise-induced hearing impairment, and the adoption of noise protection and effective measures to reduce noise at the source.
- Easy operation — The only operations are power ON/OFF and measurement START/STOP buttons
- Compact and lightweight — Workers feel no burden about 72 g
- Automatic calibration — Convenient for acoustic calibration before and after measurement

#### Easy operation

##### Procedure of noise exposure measurement

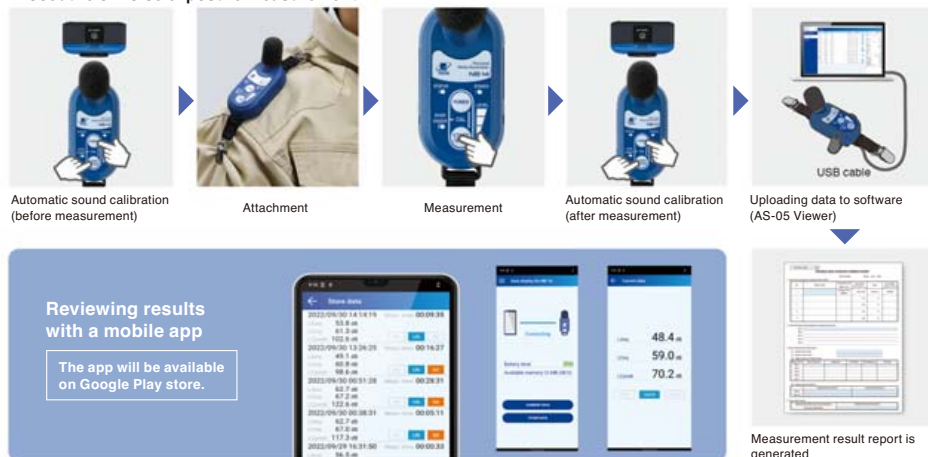

#### Specifications

|  |   |
|--|---|
| Applicable standards   | IEC 61252:1993+AMD1:2000+AMD2:2017, IEC 61672-1:2013 class 2, JIS C 1509-1:2017 class 2, VCCI Class B<br>Enables measurements in compliance with ISO 9612.<br>CE Marking<br>•EMC Directive 2014/30/EU<br>•RoHS Directive 2011/65/EU<br>UKCA Marking, China RoHS |
| Measurement function (Measures each calculated value at the same time) | Equivalent continuous A-weighted sound level $L_{Aeq}$ , Equivalent continuous C-weighted sound level $L_{Ceq}$ , C-weighted peak sound level $L_{Cpeak}$ , Percentage of the legal limit of a physical quantity of exposure DOSE                               |
| Measurement level range  | Equivalent continuous A-weighted sound level 58 dB to 143 dB<br>Equivalent continuous C-weighted sound level 58 dB to 143 dB<br>C-weighted peak sound level 75 dB to 146 dB   |
| Measurement frequency range  | 20 Hz to 8 kHz  |
| Power  | Built-in lithium-ion rechargeable battery (secondary battery), Continuous operating time: 12 hours or more from a fully charged state (within the operating temperature range)  |
| Dimensions, weight   | 85 mm (H) × 43 mm (W) × 22 mm (D) / Approx. 72 g (excluding Crocodile clip holder)  |



#### Options

### Sound calibrator NC-75

## Noise Dosimeter Data Management Software AS-05 Viewer

- The AS-05 Viewer Noise Dosimeter Data Management Software reads data measured by the NB-14 Noise Dosimeter into a computer for viewing measurement data and outputting reports.

#### Measurement results report

Retention period: 3 years

**PERSONAL NOISE EXPOSURE SUMMARY REPORT**

Date created: 2023/07/06 13:55

1. Personal noise exposure measurement results

| No. | Object work | Start/end time<br>Meas. time | Equivalent sound level $L_{Aeq}$ | Dose    | Permissible exposure time |
|-----|-------------|------------------------------|----------------------------------|---------|---------------------------|
| 1   |             | 09:00/17:00<br>8h00m         | 85.0 dB                          | 100.0 % | 8h00m                     |
| 2   |             |                              | dB                               | %       |                           |
| 3   |             |                              | dB                               | %       |                           |

#### DOWNLOAD

Available for free download from the RION website



Graphical display of the data

# Acoustics

**Comprehensive solution for aircraft noise management supporting noise and flight track data together.**

## R-EMS (RION-Environmental Managing System)

- Acquire aircraft noise report with detailed aircraft information.
- Observe flight tracking data using ADS-B and PSSR\* even in situations where radar data from airport cannot be provided.  
\* PSSR (Passive Secondary Surveillance Radar) is RION's unique technology, which can observe flight-tracking information for all aircraft including one without ADS-B.
- Sound Arrival Direction information can identify the noise events even when there are large noise sources other than aircraft nearby, or when it is difficult to identify noise events by flight tracks.
- Special microphone with excellent weather resistance, allowing accurate measurements even in the rainy and humid climate.

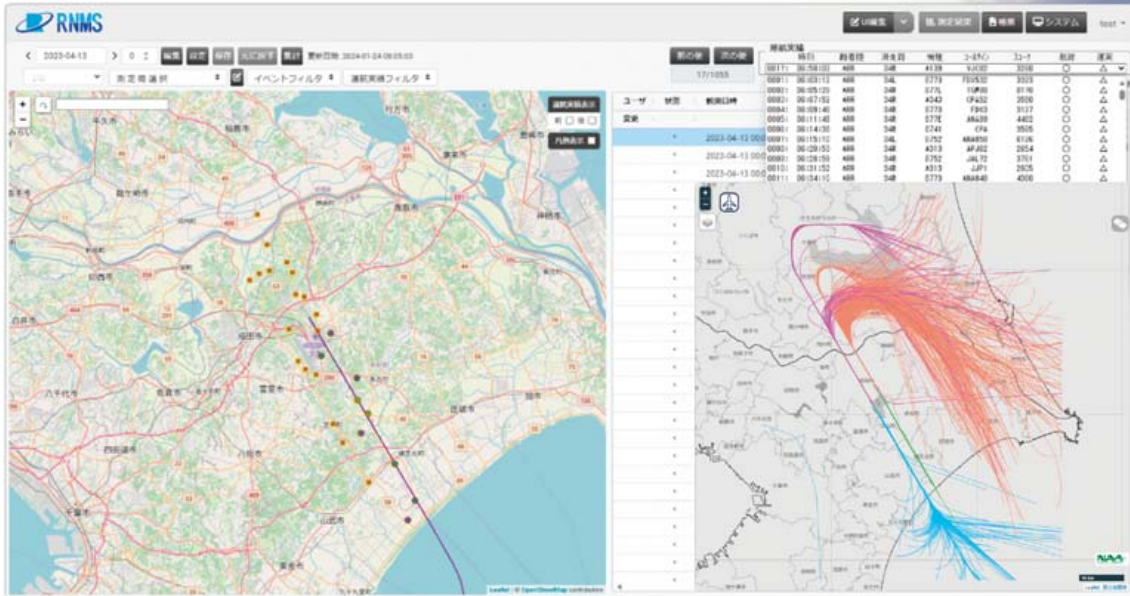

## Overview

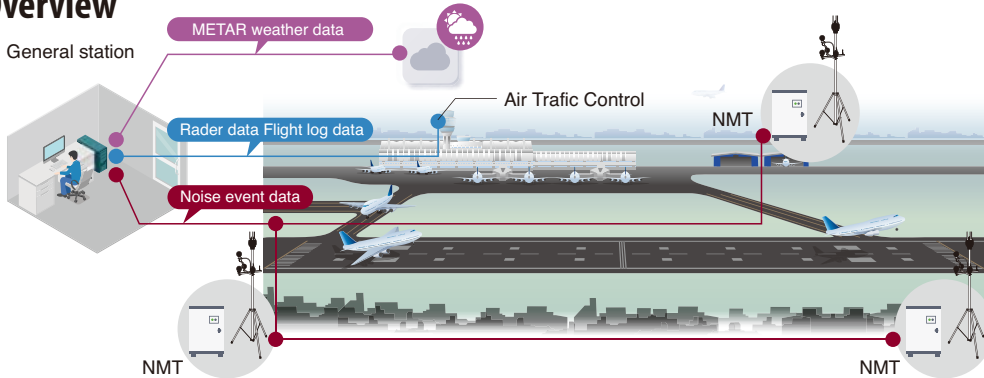

- The NMTs, noise monitoring terminals are installed around an airport. The monitoring must be continued with stable operation for long time and will be unattended. The durable NMT have communication function for concentrating all data onto data server. The data is controlled on central station and will be used for several purpose.

## Noise Monitoring Terminal

### Sound Level Meter NA-39A

- Designed for long-term monitoring.



### Outdoor Microphone MS-11A

- Built-in sound source for automatically checking the microphone sensitivity.
- Built-in Heater for preventing condensation on microphone membrane.



### Sound Arrival Direction Sensor NA-39D

The sensor structured by 4 microphones detects vertical/horizontal sound arrival direction to identify whether the sound source is aircraft.

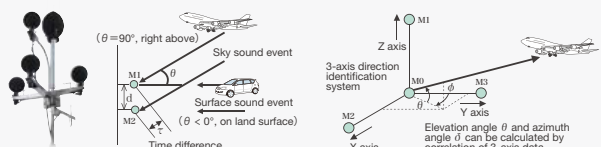

## PSSR (Passive Secondary Surveillance Radar)

- Observe the positioning information of an aircraft by receiving interrogation radio waves from the air traffic control radar and response radio waves from the transponder installed on the aircraft.

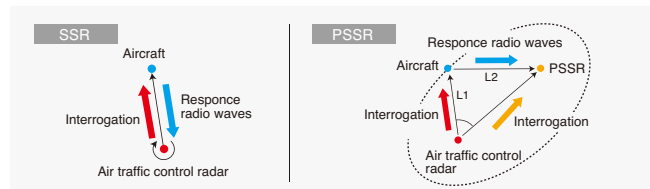

## R-EMS supports...

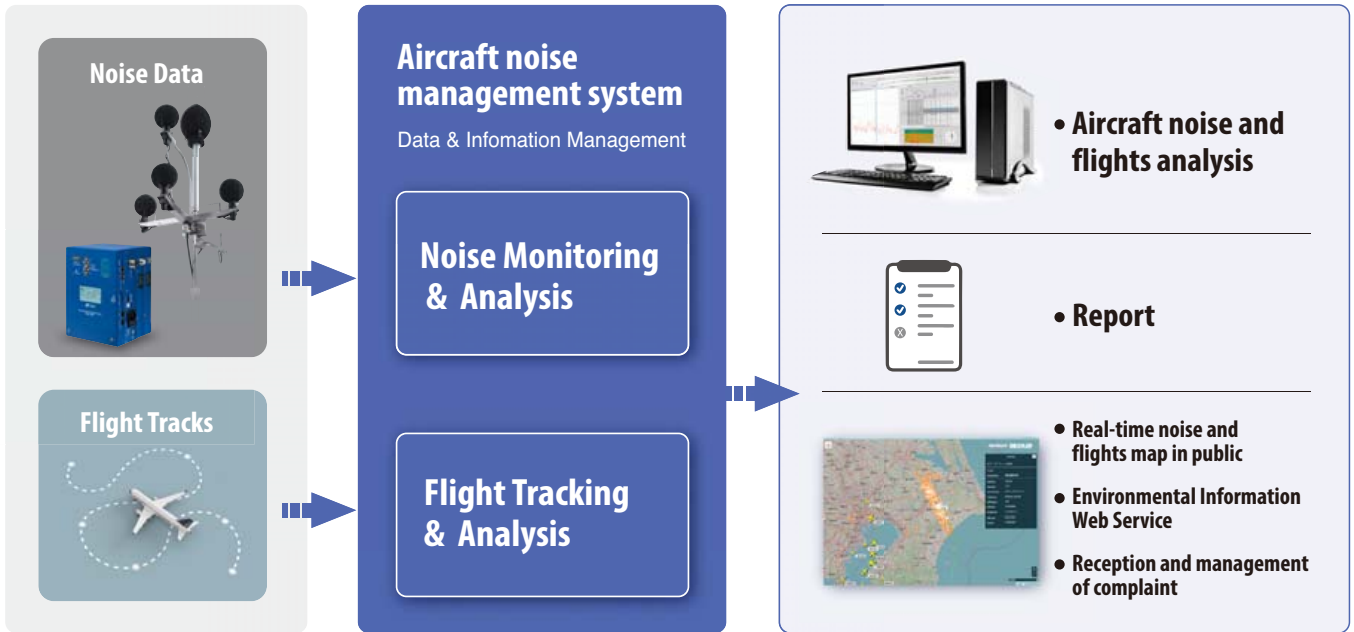

### Aircraft noise and flights analysis

- Automatically identifies which aircraft generated the observed noise data. Calculates noise evaluation values ( $L_{dn}$ ,  $L_{den}$ , etc.) and analyzes noise generation status by time of the day.

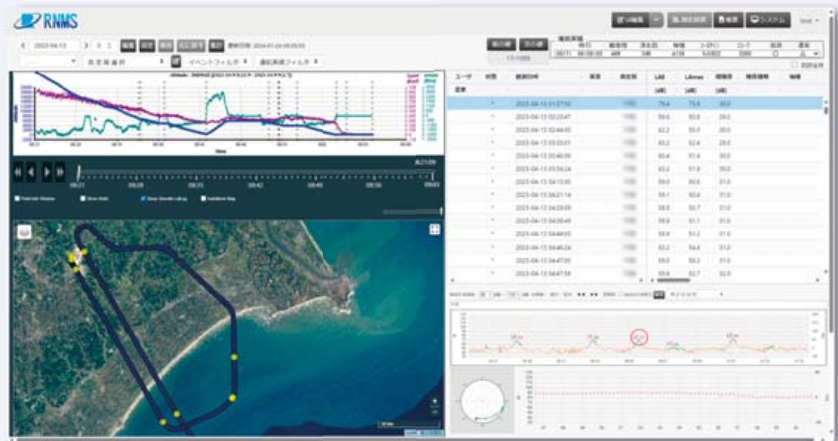

### Report

- Creates an annual noise report for environmental impact.
- Creates period summary report for publishing breaking news for surrounding residents.

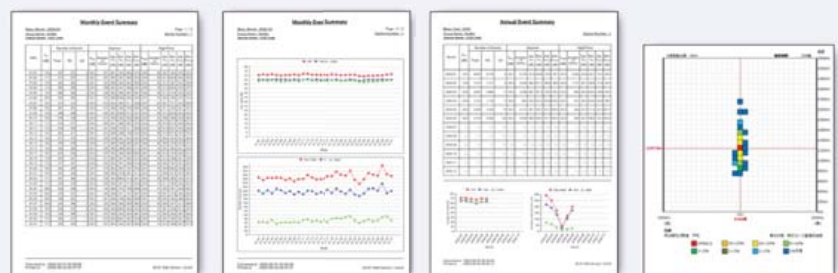

### Real-time noise and flights map in public

- Flight track information and preliminary noise data can be published on the Internet in real-time.

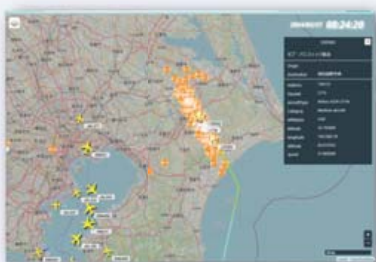

### Environmental Information Web Service

- Provides easy-to-customize web platform where you can introduce your environmental policy, noise monitoring network, noise measures and other initiatives being implemented.

### Reception and management of complaint

- Residents can post noise complaints with necessary information through dedicated contact form.
- The complaint information is associated with flight track information and noise data so that an operator can understand the relevance between complaint and flights.

# Acoustics

## Nor850-MF1

The Nor850-MF1 rack is designed to contain up to 10 measurement channels. Each channel module has the same features and specifications as the Nor140, but can only be remotely controlled from the Nor850 Suite via LAN interface. For wireless connection, a router is attached to the LAN connector. The rack is powered by 115/230 Vac or by 12Vdc. The Nor850-MF1 rack is delivered with a selectable number of measurement channels, and may be upgraded with additional channels as the needs grow. Multiple racks may be used in the same system alternatively in a mix with Nor140, Nor145 or Nor150 Sound Level Meters as additional frontends. Optionally, selected channels may be fitted with signal generator outputs.

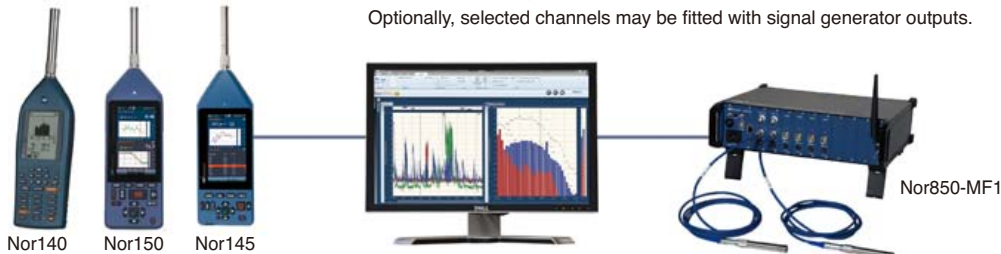

## Measurement System Nor850

The Nor850 measurement system is the state-of-the-art acoustical analyser from Norsonic. Using the experiences and accumulated knowhow from the previous generations of analysers such as Nor811, Nor823, Nor830 and Nor840, Norsonic is offering a unique multichannel system.

The software Nor850 Suite is connecting a variable number of individual measuring units to create the optimal system that suits any measurement task. Dedicated user-friendly offer the following application packages.



### General Analyser Mode

The General Mode allows the user to make multispecter measurements in all channels simultaneously with various settings for frequency range and level profiles. The profiles have user-defined period lengths from a few msec to several minutes. The results are presented in user-defined setups with both level vs. frequency and level vs. time views as well as tables. Special views for 3D or Spectrogram are also available.



### Building Acoustic Mode

The basic Building Acoustics application package includes all required features for performing sound insulation tests in the field. Both the traditional ISO 140 Standards as well as ISO 16283 Standards are included, plus national varieties of these. The ASTM standards E336, E90 as well as the E413 are also included. In the extended Building Acoustics package the more advanced laboratory test such as ISO 10140 as well as ASTM E1007, E492 and E989 are included together with absorption coefficient testing in accordance with ISO 354 and ASTM C423.



### Sound Power Mode

The basic Sound Power application package includes all features required for making sound power test in accordance with the various Standards in the ISO 3740 series. The extended Sound Power application package contains required features for making more special tests such as dual-chamber testing of heat-pumps, dynamic testing of earth moving machinery, and similar. The entire test procedure may be controlled by a user defined Scheduler for easy test repetitions.



### Appliance Noise Mode

The Appliance Noise application package includes the requires features to perform a full laboratory test of the ISO 3822 Noise emission from appliances and equipment used in water supply installations.



## Tapping Machine Light Floor Impact Sound Generator FI-01A/Nor277

#### Specifications

|   |  |
|---|--|
| Applicable standards                              | ISO 10140-5, ISO 16283-2                                     |
| Hammers Number and Spacing                        | 5 hammers are arrayed at 100 mm intervals in a straight line |
| Average time between floor impacts of each hammer | 100 ± 5 ms   |
| Interface   | RS-232C  |
| Dimensions, Weight                                | Approx. 230 (H) x 265 (W) x 557 (D) mm, approx. 10 kg        |



## Impact Ball YI-01

#### Specifications

|                     |  |
|---------------------|--|
| Equivalent mass     | 2.5 ± 0.1 kg   |
| Drop height         | 1 m  |
| Shape               | Hollow sphere with 32 mm thick wall and 178 mm external diameter |
| Rebound coefficient | 0.8 ± 0.1  |



## Heavy Floor Impact Source FI-02

- Heavy and soft impact source suitable for floor impact sound level measurement,
- simulating events such as children jumping up and down

Can be used to evaluate mainly the medium and low frequency range insulation aspect in the acoustic performance of floor structures

JIS A 1418-2: 2019 Standard Heavy Impact Source (impact force characteristics 1)



(Nor282)

## Dodecahedron Loudspeaker

### Nor283

- Dodecahedron loudspeaker
- High power loudspeaker with omnidirectional characteristics
- Fulfils the directional characteristics required by the ISO 10140 and ISO 16283 Standards
- Supplied with individual omni directional calibration certificate
- Fulfils ISO 3382-2
- Delivers a continuous sound power level of 123 dB when driven with pink noise over the frequency range 50 to 5000 Hz via the Nor282 Power Amplifier



## Power Amplifier

### Nor282

- Specially designed for building acoustic and room acoustic measurements.
- Battery operated (90 minutes at full power)
- Graphical user defined equalizer to optimize acoustic output from speaker.
- Wi-Fi for easy connect to Norsonic measuring equipment.
- Compact, lightweight, and rugged construction.
- Self-contained noise generator.
- Emits 120 dB sound power level in the 50 to 5000 Hz frequency range when used with Norsonic loudspeakers types Nor275 or Nor276.
- Wireless Noise on/off hand switch.



## Microphone Boom

### Nor265A

- Oscillating microphone boom for spatial averaging in building acoustics or sound power measurements
- Building acoustics measurements in accordance with ISO 10140 and ISO 16283
- Reverberation time measurements in accordance with ISO 354
- Sound Power measurements in accordance with ISO 3740 series.
- Directional response measurements of loudspeakers and microphones
- Accurate positioning
- Sweep of  $\pm 90^\circ$  and  $\pm 180^\circ$
- Direct control or remote control from a PC via LAN interface
- Supported by Nor850
- User defined sweeps. Selectable sweep times
- Boom length adjustable from 0,8
- Nor265A may be equipped with a turntable (optionally)



## Reference Sound Source

### Nor278

#### Applications

- Substitution and juxtaposition methods for determination of sound power of noise sources according to ISO 3747
- Comparison method for determination of sound power of noise sources according to ISO 3741, ISO 3743-1, ISO 3744 and 3747

#### Features

- A-weighted Sound power output : 93 dB re 1 pW (50 Hz line frequency)
- Sound power 50 Hz to 20 kHz: 94 dB re 1 pW (50 Hz line frequency)
- Fulfils ISO 6926 for reference sound sources in the extended frequency range 50 Hz to 10 kHz
- Individually calibrated (accredited calibration optional)
- Long-term stability
- Rugged

# Acoustics

**Achieves high dynamic range using overwhelming number of microphones**

## Acoustic camera

### Hextile/Multitile/Multitile-LF (for low-frequency analysis)



- Realtime display of high-resolution color maps generated by high-speed data processing and beamforming
- The hexagonal microphone array module offers expandable functionality. The Multitile-LF for low-frequency analysis can process sound in the 120 Hz–1 kHz frequency range.
- Recorded data is stored in MP4 format for subsequent reanalysis.
- Available display modes include FFT analysis, octave band analysis, and spectral mapping.
- The array of microphones can be connected using USB cables to allow easy settings and power supply.
- Camera view lets users experience sounds (virtually) at a specified point simply by selecting a point with the cursor.



Computer



Hextile



Multitile



Multitile-LF (for low-frequency analysis)

| Specifications for microphone array                | Hextile  | Multitile        | Multitile-LF (for low-frequency analysis) |
|--|--|------------------|---|
| Measurement frequency range                        | 410 Hz to 20 kHz                                   | 220 Hz to 20 kHz | 120 Hz to 1 kHz                           |
| Number of microphones installed in unit            | 128  | 384              | 384                                       |
| External dimensions                                | φ48 cm   | φ96 cm           | φ146 cm                                   |
| Measurement level range (system)                   | 9 dB to 120 dB                                     |                  |   |
| Minimum measurement distance                       | 0.5 m  |                  |   |
| Frame rate (at camera resolution of 2,592 × 1,944) | 15 FPS   |                  |   |
| Operating temperature range                        | -40 °C to +85 °C                                   |                  |   |
| Water resistance                                   | IP40   |                  |   |
| Computer   | MacBook Pro Intel Core i7, SSD, RAM : 8 GB or more |                  |   |
| DC power source                                    | USB 5 V  |                  |   |

**Easy × Light × Compact × Visualization**

## Acoustic Camera SC-AC043

- This innovative portable system combines a 30-microphone array with a tablet computer to enable visualization of sound sources.
- Possible applications include product development and on-site troubleshooting.
- Problematic sound sources can be quickly located, and the efficiency of countermeasures can be checked visually.

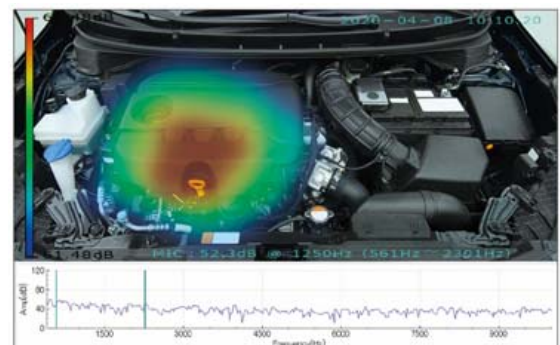

Measurement screen examples (simulated)



## Normal incidence sound absorption coefficient measuring device using two-microphone method

# Normal incidence Acoustic Measurement System Impedance Tube

- Within an Impedance tube, the reflected sound or transmitted sound from sound hitting the sound absorbing material or sound insulation material surface vertically is captured to measure the sound absorption coefficient, acoustic impedance, and related values, as well as the sound reduction index of a material.
- The results can serve for evaluation and for determining the physical properties of sound absorbing material, sound insulation material and similar materials used for example to achieve weight reduction in automobiles or high-rise buildings.



### Specifications

| Model                | Model 9301   | Model 9302   | Model 9303                             | Model 9305   |
|----------------------|--|--|--|--|
| Applicable standards | JIS A 1405-2, ISO 10534-2  |  | JIS A 1405-2, ISO 10534-2, ISO 13472-2 | JIS A 1405-2, ISO 10534-2  |
| Measurement range    | Low-frequency tube   | 100 Hz to 1 600 Hz   | 125 Hz to 1 600 Hz                     | —  |
|                      | High-frequency tube  | 500 Hz to 6 300 Hz   | 500 Hz to 6 300 Hz                     | 1 000 Hz to 10 000 Hz  |
| Application          | Measurement of the sound absorption coefficient and acoustic impedance related items of sound absorbing Material<br>Measurement of normal incidence sound reduction index of sound insulation material | Measurement of the sound absorption coefficient and acoustic impedance related items of sound absorbing material | —                                      | High frequency measurement up to 10 000 Hz<br>Ideal for measuring acoustic characteristics of sound absorbing and insulating materials for use in electric vehicles and other applications |

## Model 9301 Normal incidence Sound Absorption Coefficient/ Sound Reduction Index Measurement System

Measures the sound absorption coefficient and acoustic impedance related items of sound absorbing material and the vertical incidence sound reduction index of sound insulation material.



### Model 9302 Normal incidence Sound Absorption Coefficient Measurement System

Measures the sound absorption coefficient and acoustic impedance related items of sound absorbing material.

### Model 9303 Road Surface Sound Absorption Coefficient Measurement System

Designed for on-site measurements of the sound absorption coefficient of road surfaces, used in running vehicle noise tests. Enables similar measurements as the Model 9302.

### Model 9305 Normal incidence Sound Absorption Coefficient/ Sound Reduction Index Measurement System for High Frequency Measurement

Measures frequencies up to 10000 Hz; ideal for measuring acoustic characteristics of sound absorbing and insulating materials for use in electric vehicles and other applications.

## Carefully controlled acoustic properties provide a stable and quiet environment for measurements

### Anechoic Box (Compact Type)



- Suitable for use in testing and developing small size precision instruments
- Wedge-shaped absorber layer provides high sound absorption efficiency
- Available as standard Type L, or Type H with higher sound insulation and absorption characteristics

#### Sound insulation performance (Type L)

● Measured according to JIS A 1417. Results may differ slightly, depending on construction of installation location (floor, walls, ceiling) and ambient noise level.

| Frequency        | (63 Hz) | 125 Hz | 250 Hz | 500 Hz | 1 kHz | 2 kHz | 4 kHz |
|------------------|---------|--------|--------|--------|-------|-------|-------|
| Sound insulation | 10 dB   | 15 dB  | 23 dB  | 30 dB  | 35 dB | 40 dB | 40 dB |

\*Deviation -3 dB or more \*Figures in brackets are reference values

### Anechoic Room



- Can be assembled on site in existing buildings, which helps to keep costs low
- Enhanced sound insulation performance and additional facilities available as options
- Available as standard Type L, or Type H with higher sound insulation and absorption characteristics

#### Sound insulation performance (Type L/Type H)

● Measured according to JIS A 1417. Results may differ slightly, depending on construction of installation location (floor, walls, ceiling) and ambient noise level.

| Frequency        | (63 Hz) | 125 Hz | 250 Hz | 500 Hz | 1 kHz | 2 kHz | 4 kHz |
|------------------|---------|--------|--------|--------|-------|-------|-------|
| Sound insulation | 32 dB   | 39 dB  | 43 dB  | 44 dB  | 56 dB | 62 dB | 64 dB |

\*Deviation -3 dB or more \*Figures in brackets are reference values

### Sound Proof Chamber



- Can be assembled on site in a short time
- Suitable for many applications, including acoustic measurements of small machinery and equipment, sound-shielded environment configuration, acoustic testing, hearing level testing and more
- Enhanced sound insulation performance and additional facilities available as options

#### Sound insulation performance

● Measured according to JIS A 1417. Results may differ slightly, depending on construction of installation location (floor, walls, ceiling) and ambient noise level.

| Frequency        | (63 Hz) | 125 Hz | 250 Hz | 500 Hz | 1 kHz | 2 kHz | 4 kHz |
|------------------|---------|--------|--------|--------|-------|-------|-------|
| Sound insulation | 25 dB   | 32 dB  | 38 dB  | 50 dB  | 53 dB | 55 dB | 58 dB |

\*Deviation -3 dB or more \*Figures in brackets are reference values

## Condenser Microphone UC Series

- 1" microphone: For ultra-low sound pressure levels: upper measurement frequency up to about 10 kHz
- 1/2" microphone: For a wide range of acoustic applications
- 1/4" microphone: For high frequencies and high sound pressure levels



| Model  | UC-27           | UC-34P         | UC-35P <small>€€</small> | UC-30 <small>€€</small> | UC-31 <small>€€</small> | UC-33P          | UC-52 <small>€€</small> | UC-59 <small>€€</small>                  | UC-57 <small>€€</small>                   | UC-29 <small>€€</small>     | UC-54 <small>€€</small>                  |
|--|-----------------|----------------|--------------------------|-------------------------|-------------------------|-----------------|-------------------------|--|---|-----------------------------|--|
| Suitable preamplifier  | NH-06B          | NH-34 supplied | NH-35 supplied           | NH-04B/05B/12A          | NH-04B/05B/12A          | NH-04B/05B/12A  | NH-17/17A/22A           | NH-17/17A/22A                            | NH-17/17A/22A                             | NH-05B (using UA-12)        | NH-17/17A/22A (using UA-12)              |
| Nominal diameter   | 1 inch          |                |                          | 1/2 inch                |                         |                 |                         |  |   | 1/4 inch                    |  |
| Frequency response   | Sound field     | Sound field    | Sound field              | Sound field             | Sound field             | Sound pressure  | Sound field             | Sound field                              | Sound field                               | Sound field                 | Sound field                              |
| Measurement frequency range (Hz)                                       | 5 to 12 500     | 10 to 12 500   | 10 to 12 500             | 10 to 20 000            | 10 to 35 000            | 10 to 20 000    | 20 to 8 000             | 10 to 20 000                             | 10 to 16 000                              | 20 to 100 000 <sup>*2</sup> | 20 to 100 000 <sup>*2</sup>              |
| Bias voltage (V)   | 200             | 200            | 0                        | 200                     | 200                     | 200             | 0                       | 0  | 0   | 200                         | 0  |
| Sensitivity level (dB re 1 V/Pa) <sup>*1</sup>                         | -26.5           | -21~-1         | 0                        | -25.5                   | -37                     | -38             | -33                     | -27                                      | -22                                       | -47                         | -48                                      |
| Capacitance (pF)   | 54              | —              | —                        | 17                      | 20                      | 20              | 19                      | 13                                       | 14  | 6                           | 4  |
| Maximum input sound pressure level (dB) (Linearity tolerance ± 0.3 dB) | 152             | —              | 96                       | 144                     | 160 <sup>*4</sup>       | 160             | 150                     | 148                                      | 132 <sup>*4</sup>                         | 164 <sup>*4</sup>           | 164                                      |
| Inherent noise level (dB)  | 12              | 2              | 4                        | 20                      | 26                      | 28              | 24                      | 18                                       | 13  | 42                          | 45                                       |
| Temperature coefficient (dB/°C)  | -0.005          | —              | —                        | -0.007                  | -0.007                  | -0.009          | -0.008                  | within ±0.35 dB (at 1 kHz) <sup>*3</sup> | within ±0.45 dB (at 250 Hz) <sup>*3</sup> | -0.01                       | within ±0.7 dB (at 250 Hz) <sup>*3</sup> |
| Diaphragm  | Titanium alloy  |                |                          |                         |                         |                 |                         |  |   | Titanium                    |  |
| Dimensions (mm)  | dia.23.8 x 21.0 | dia.23.8 x 131 | dia.23.8 x 132.7         | dia.13.2 x 15.0         | dia.13.2 x 13.2         | dia.13.2 x 13.0 | dia.13.2 x 12.0         | dia.13.2 x 14.3                          | dia.13.2 x 13.5                           | dia.7.0 x 10.0              | dia.7.0 x 10.0                           |

<sup>\*1</sup> Representative value for 1 kHz <sup>\*2</sup> UC-29/54 frequency range refers to microphone without grid. <sup>\*3</sup> -10 °C to +50 °C referenced to 23 °C <sup>\*4</sup> Distortion 3 %  
<sup>\*5</sup> Depend on connected instrument

## Microphone With Preamplifier

- TEDS compliant



## Preamplifiers NH Series

- Faithful transmission of voltage signal generated by microphone to subsequent amplifier stages
- Versatile preamplifier lineup allows choosing the best combination of diameter and microphone type



| Model                                | UC-52T <small>€€</small> | UC-57T <small>€€</small> | UC-59T <small>€€</small> |
|--------------------------------------|--------------------------|--------------------------|--------------------------|
| Microphones                          | UC-52                    | UC-57                    | UC-59                    |
| Nominal diameter                     | 1/2 inch                 |                          |                          |
| Frequency response                   | Sound field              | Sound field              | Sound field              |
| Measurement frequency range (Hz)     | 20~8 000                 | 10~16 000                | 10~20 000                |
| Drive current                        | 2 mA~4 mA                | 2 mA~4 mA                | 2 mA~4 mA                |
| A-weighted inherent noise level (dB) | 24                       | 13                       | 18                       |
| Dimensions (mm)                      | φ13.2x97                 | φ13.2x98.5               | φ13.2x99.4               |
| Cable type                           | EC-90 series (BNC)       | EC-90 series (BNC)       | EC-90 series (BNC)       |

| Model                                | NH-06B             | NH-04B                           | NH-12A                | NH-17                         | NH-17A                        | NH-22A <small>€€</small>  | NH-05B                           |
|--------------------------------------|--------------------|----------------------------------|-----------------------|-------------------------------|-------------------------------|---|----------------------------------|
| Suitable microphones                 | UC-27              | UC-30/31/33P                     | UC-30/31/33P          | UC-52/54 <sup>*1</sup> /57/59 | UC-52/54 <sup>*1</sup> /57/59 | UC-52/54 <sup>*1</sup> /57/59 (constant current drive) 2 mA to 4 mA | UC-29 <sup>*1</sup> UC-30/31/33P |
| Nominal diameter                     | 1 inch             | 1/2 inch, 1/4 inch <sup>*1</sup> |                       |                               |                               |   | 1/2 inch, 1/4 inch               |
| Input impedance (GΩ)                 | 3                  | 3                                | 3                     | 3                             | 3                             | 6   | 10                               |
| Input capacitance (pF)               | 0.3                | 0.25                             | 0.25                  | 0.8                           | 0.8                           | 0.7   | 0.2                              |
| Measurement frequency range (Hz)     | 5 to 100 000       | 10 to 100 000                    | 10 to 100 000         | 10 to 100 000                 | 10 to 100 000                 | 10 to 100 000   | 10 to 100 000                    |
| Bias voltage (V)                     | 200                | 200                              | 200                   | 0                             | 0                             | 0   | 200                              |
| Gain (dB), representative value      | -0.1(54 pF)(UC-27) | -0.2(17 pF)(UC-30)               | -0.2(17 pF)(UC-30)    | -0.5(13 pF)(UC-59)            | -0.5(13 pF)(UC-59)            | -0.5(13 pF)(UC-59)  | -0.5(6 pF)(UC-29) <sup>*1</sup>  |
| A-weighted inherent noise level (dB) | 12 (UC-27)         | 20 (UC-30)                       | 20 (UC-30)            | 18 (UC-59)                    | 18 (UC-59)                    | 18 (UC-59)  | 42 (UC-29)                       |
| Output impedance (Ω)                 | 100 or less        | 100 or less                      | 100 or less           | 300 or less                   | 300 or less                   | approx. 30  | 100 or less                      |
| Cable type                           | EC-04 series (7P)  |                                  | 1.5 m integrated (7P) | 5 m integrated (7P)           | EC-04 series (7P)             | EC-90 series (BNC)  | EC-04 series (7P)                |

<sup>\*1</sup> Using UA-12

**TEDS** TEDS (Transducer Electronic Data Sheet) is a format for sensor-specific information defined by the IEEE 1451 series of standards. It includes the data listed below and allows automatic calibration when the sensor is connected to TEDS compliant equipment.

**TEDS data** Manufacturer ID, Model, Serial number, Sensitivity, Calibration date, etc.

**For a wide range of high-precision acoustic measurements**

**Measuring Amplifier  
NA-42**  
(without microphone)



- Supports connection of low-noise microphones UC-34P and UC-57 as well as microphones UC-29/54 and others allowing measurement up to 100 kHz

**Specifications**

|  |   |
|--|---|
| Measurement functions                  | Sound pressure level $L_p$ , maximum sound level $L_{max}$ , peak sound pressure level $L_{peak}$ |
| Measurement frequency range            | 1 Hz to 100 kHz (main unit characteristics)   |
| Frequency weighting characteristics    | A, C, FLAT  |
| Time weighting characteristics         | F (Fast), S (Slow), I (Impulse)   |
| External filter input/output connector | BNC connector   |

**Build flexible measurement systems for simultaneous measurement of sound and vibrations**

**Sound Level Meter Unit  
UN-14**

TEDS compliant



- Sound Level Meter Unit UN-14 and Vibration Meter Unit UV-15 can be linked in a measurement system with up to 16 channels
- Linking with Interface Unit UV-22 allows setup and control from a computer, and transfer of measurement values

**Specifications**

|                                     |  |  |
|-------------------------------------|--|--|
| Inputs                              | 7-pin input connector  | For measurement microphone or preamplifier (max. input voltage $\pm 10$ V) (excl. UC-34P connection)   |
|                                     | BNC connector  | For CCLD compliant microphone or preamplifier (24 V 4 mA)<br>For TEDS compliant microphone (24 V 4 mA) |
| Frequency weighting characteristics | A, C, Z (JIS C 1509-1 class 1, IEC 61672 class 1 electrical characteristics) |  |
| Frequency range                     | 1 Hz to 80 kHz (20 Hz to 40 kHz $\pm 0.5$ dB) (1 Hz to 80 kHz $\pm 3$ dB)    |  |
| Time weighting characteristics      | F, S, 10 ms (JIS C 1509-1 class 1 electrical characteristics)                |  |

**Optional accessories (For Sound Level Measurement)**

**114 dB/250 Hz calibration sound source**

**Pistonphone  
NC-72B**



- Suitable for high-precision calibration of 1, 1/2, and 1/4 inch microphones
- Powered by AA batteries (alkaline, manganese, NiMH) x 6, alkaline for 15 hours and NiMH for 13 hours continuous use at room temperature

**Specifications**

|                              |  |
|------------------------------|--|
| Applicable standards         | IEC 60942:2017 class LS/M, class 1/M, ANSI/ASA S1.40-2006 (R2016) class LS/C, class 1/C, JIS C 1515:2020 class LS/M, class 1/M |
| Nominal sound pressure level | 114 dB Specified sound pressure level tolerance $\pm 0.1$ % (101.325 kPa)  |
| Nominal frequency            | 250 Hz Specified frequency tolerance $\pm 0.1$ %   |

**Compensation for atmospheric pressure not required**

**Sound Calibrator  
NC-75**



- Compact, lightweight, and easy to use unit that meets the performance requirements for calibrating high-precision sound level meters
- Operates on two IEC R6 (size AA) batteries (alkaline or nickel-hydride), enabling continuous operation for at least 50 hours at room temperature

**Specifications**

|                              |   |
|------------------------------|---|
| Applicable standards         | IEC 60942: 2017 class 1, JIS C 1515: 2020 class 1 |
| Compatible microphones       | 1 inch, 1/2 inch, and 1/4 inch types              |
| Nominal sound pressure level | 94 dB   |
| Nominal frequency            | 1 000 Hz  |

**Class 1  
Sound Calibrator  
Nor1256**



- Conforms to IEC 60942 : 2017 Class 1 and ANSI/ASA S1.40-2006 (R2016) Class 1
- Ultra-stabile silicone reference microphone
- Fully compensated for static pressure, humidity and temperature
- Robust, compact and battery operated.
- 114 and 94 dB @ 1000 and 250 Hz
- Built in display
- Measurement of humidity, temperature and static pressure
- Supplied with accredited calibration certificate

**Reduce adverse effects of wind noise  
Windscreens**



| Type                                | Model   |
|-------------------------------------|---------|
| Windscreen for 1/2 inch microphones | WS-10   |
| Windscreen for 1 inch microphones   | WS-01   |
| Windscreen for 1/4 inch microphones | WS-05   |
| All-weather windscreen              | WS-15   |
| Windscreen mounting adapter         | WS15006 |
| Rain-protection windscreen          | WS-16   |

**Dual Windscreen to minimize influence of wind noise**

**Noise Measurement for wind turbine**

**Dual Windscreen for Wind Turbine Noise Measurement  
TWS-01**



**Acoustic Power Level measurement for wind turbine**

**Windscreen  
KWS-03**



Acoustics

Vibration

Frequency Analysis

Recording

Related Products

Measuring Instrument Combinations  
External view drawings

Outline

Knowledge in a Nutshell

Company Outline

# Acoustics

## Measurement Microphone Combination Examples

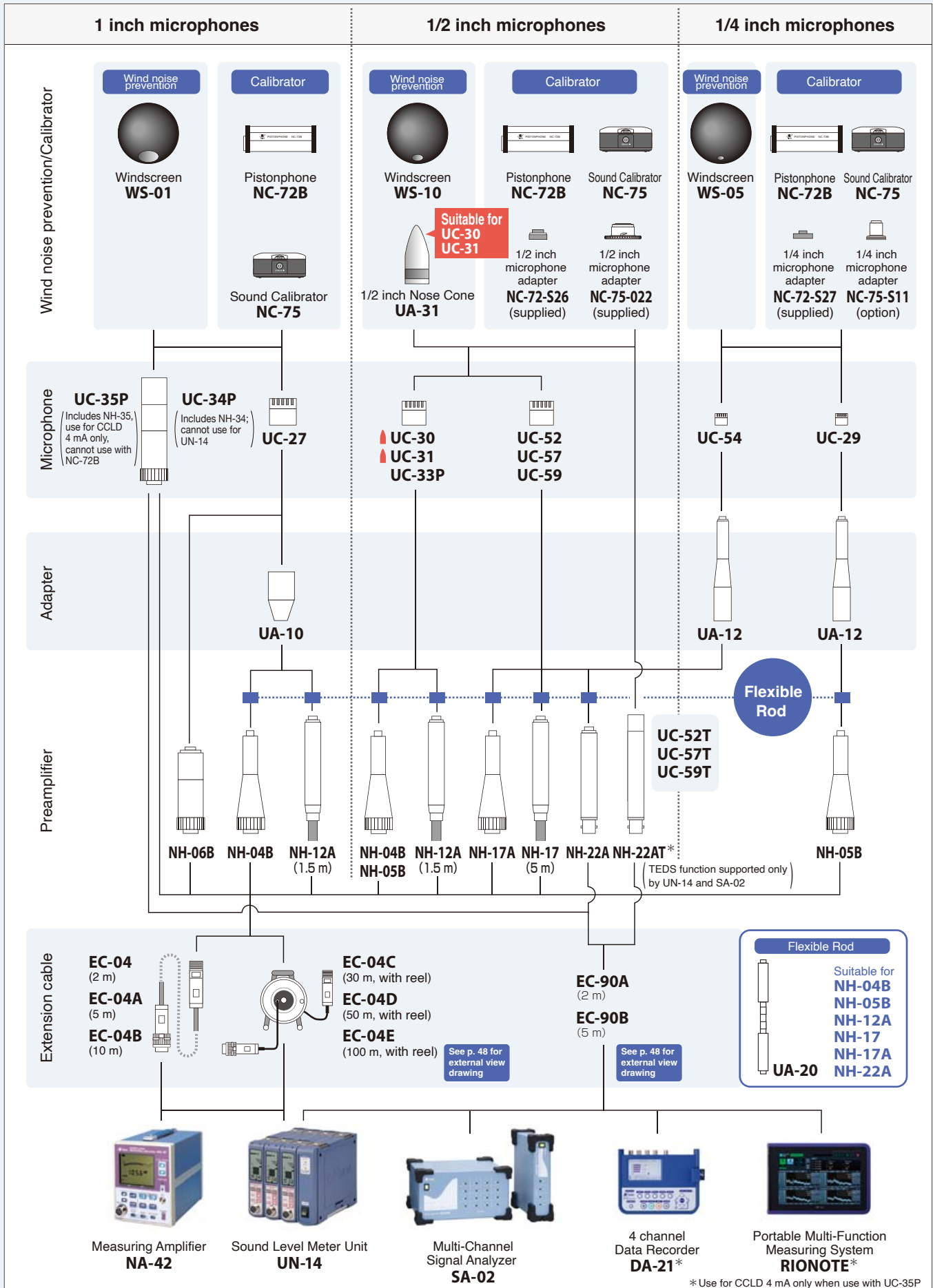



# Sound Level Meter Connection Examples

| AC Adapter   | Sound Level Meter   | Connection Cable  | Peripheral Equipment  |
|--|---|---|---|
| <p>AC Adapter <b>NE-21P</b></p> <p>Battery Pack <b>BP-21A*</b><br/>* Required CC-43J</p> | <p><b>Meter with integrated microphone</b></p> <p>Sound Level Meter <b>NL-43</b></p>        | <p>USB Type-C Cable</p> <p>Computer</p>   | <p><b>Sound Calibrator</b></p> <p>Pistonphone <b>NC-72B</b></p> <p>Sound Calibrator <b>NC-75</b></p> <p><b>Computer</b></p> <p><b>Computer</b></p> <p>* For information on software for various measurements, see the respective sound level meter page.</p> <p><b>External device</b></p> <p>Rotating light, alarm etc.</p> <p><b>Peripheral device with BNC connector</b></p> <p>Level Recorder <b>LR-07</b></p> <p>Data Recorder <b>DA-21</b></p> <p>Multi-Channel Signal Analyzer <b>SA-02M/02A4</b></p> <p>Portable Multi-Function Measuring System <b>RIONOTE</b></p> |
|  | <p>Sound Level Meter <b>NL-53</b></p>   | <p>RS-232C Serial I/O Cable <b>CC-42R</b></p> <p>Computer</p>   |   |
|  | <p>Sound Level Meter (With low-frequency sound measurement function) <b>NL-63</b></p>       | <p>AC/DC Output splitter Cable <b>CC-43S</b><br/>*BNC-Pin output code of CC-24 or CC-24S must be connected to each output port.</p> <p>Peripheral device with BNC connector</p> <p>BNC-mini plug Cable <b>CC-24</b></p> <p>Peripheral device with BNC connector</p> <p>Comparator Output / Trigger Input Cable <b>CC-43CT</b></p> <p>Peripheral device with BNC connector</p> |   |
| <p>AC Adapter <b>NC-98E</b></p>  | <p>Sound Level Meter <b>NA-28</b></p>   | <p>USB A-mini B Cable</p> <p>Computer</p> <p>BNC-mini plug Cable <b>CC-24</b></p> <p>Peripheral device with BNC connector</p>   |   |
| <p>AC Adapter <b>NC-98E</b></p>  | <p><b>Meter with separate microphone option</b></p> <p>Measuring Amplifier <b>NA-42</b></p> | <p>Interface Cable <b>SWKR4030</b></p> <p>Computer</p> <p>BNC-BNC Cable <b>NC-39A</b></p> <p>Peripheral device with BNC connector</p> <p>BNC-BNC Coaxial Cable <b>EC-90A/90B</b><br/>* For information on comparator output connection, contact RION distributors.</p> <p>Peripheral device with BNC connector</p>  |   |
| <p>AC Adapter <b>NC-99A</b></p> <p>Battery Unit <b>BP-17</b></p>                         | <p>Sound Level Meter Unit <b>UN-14</b></p> <p>Interface Unit <b>UV-22</b></p>               | <p>USB A-mini B Cable</p> <p>Computer</p> <p>LAN Cable</p> <p>Computer</p>  |   |

Acoustics

Vibration

Frequency Analysis

Recording

Related Products

Measuring Instrument Combinations  
External view drawings









Outline







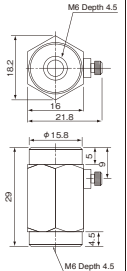
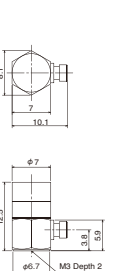
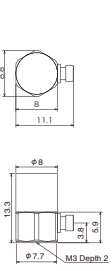
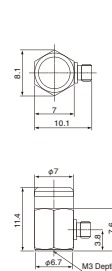
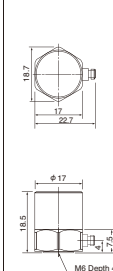
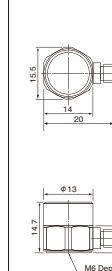
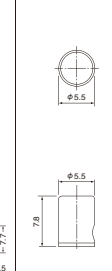
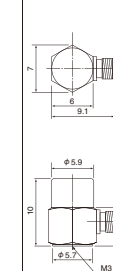
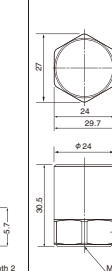

Knowledge in a Nutshell

Company Outline

# Vibration

## Piezoelectric Accelerometers

| Type   | Standard  | With built-in amplifier  |   |  | General-purpose  |   | Compact / Lightweight  |  | High-output   |
|--|---|--|---|--|--|---|--|--|---|
| External view  | <br><b>PV-03</b> | <br><b>PV-91C</b> | <br><b>PV-91CH</b> | <br><b>PV-90T</b> | <br><b>PV-85/86</b><br><small>PV-86 has top-mounted connector</small> | <br><b>PV-94/95</b><br><small>PV-95 has top-mounted connector</small> | <br><b>PV-08A</b> | <br><b>PV-90B</b> | <br><b>PV-87</b> |
| Principle  | Compression   | Shear  | Shear   | Shear  | Shear  | Shear   | Shear  | Shear  | Shear   |
| Weight g   | 38  | 1.8  | 3   | 2  | 23   | 9   | 0.7  | 1.2  | 115   |
| Charge sensitivity pC/(m/s) <sup>*1</sup>  | 0.47  | —  | —   | —  | 6.42   | 0.714   | 0.102  | 0.18   | 40  |
| Voltage sensitivity mV/(m/s) <sup>*1</sup>   | —   | 1  | 11  | 0.5  | —  | —   | —  | —  | —   |
| Vibration frequency range (±1 dB) Hz <sup>*2</sup><br>Secondary calibration range. | 20 to 1 000 (±1 %)  | 1 to 20 000 (±10 %) <sup>*3</sup>  | 1 to 15 000 (±10 %) <sup>*6</sup>   | 1 to 12 000 (±10 %)  | 1 to 7 000   | 1 to 10 000   | 1 to 25 000  | 1 to 25 000  | 1 to 3 000  |
| Mounting resonance frequency kHz <sup>*2</sup>                                     | 30  | 55   | 50  | 50   | 24/21  | 36  | 52   | 70   | 9   |
| Temperature range for use °C   | -50 to +200   | -50 to +170  | -50 to +170   | -20 to +100<br>(TEDS: -20 to +85)  | -50 to +160  | -50 to +160   | -50 to +160  | -50 to +160  | -50 to +160   |
| Supplied cable   | VP-51A (2 m)  | VP-51LC (2 m)  | VP-51LC (2 m)   | VP-51LC (2 m)  | VP-51A (2 m)   | VP-51A (2 m)  | VP-51J 38 cm <sup>*3</sup>   | VP-51L (2 m)   | VP-51A (2 m)  |
| Dimensions mm  |                 |                  |                   |                  |    |    |                  |                  |                 |

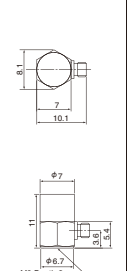
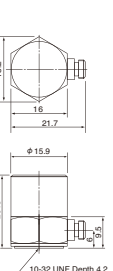
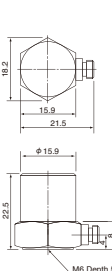
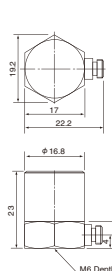
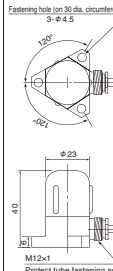
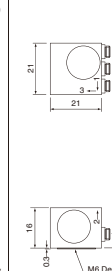
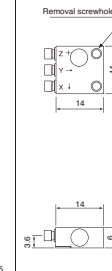
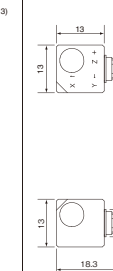
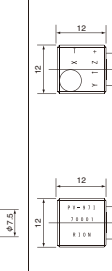
| Type   | High-temperature   |  |   |   | Waterproof insulation  | Triaxial type  |  |   |  |
|--|--|--|---|---|--|--|--|---|--|
| External view                                      | <br><b>PV-90H</b> | <br><b>PV-44A</b> | <br><b>PV-65</b> | <br><b>PV-63</b> | <br><b>PV-10B</b> | <br><b>PV-93</b> | <br><b>PV-97C</b> | <br><b>PV-97</b> | <br><b>PV-97I</b> |
| Principle  | Shear  | Compression  | Shear   | Shear   | Compression  | Shear  | Shear  | Shear   | Shear  |
| Weight g   | 2  | 29   | 26  | 28  | 120  | 30   | 4.7  | 10  | 8  |
| Charge sensitivity pC/(m/s) <sup>*1</sup>          | 0.29   | 7.65   | 7.14  | 4.59  | —  | 0.831  | 0.12   | 0.29  | —  |
| Voltage sensitivity mV/(m/s) <sup>*1</sup>         | —  | —  | —   | —   | 5.1  | —  | —  | —   | 1.1  |
| Vibration frequency range (±1 dB) Hz <sup>*2</sup> | 1 to 20 000 (±10 %)  | 1 to 10 000  | 1 to 9 000  | 1 to 8 000  | 3 to 8 000   | 1 to 8 000 (2-axis)<br>1 to 4 000 (1-3)  | 1 to 15 000 (Z)<br>1 to 10 000 (X-Y)   | 1 to 10 000 (Z)<br>1 to 5 000 (X-Y) (±10 %)   | 1 to 7 000 (Z) <sup>*4</sup><br>1 to 5 000 (X-Y) (±10 %)   |
| Mounting resonance frequency kHz <sup>*2</sup>     | 60   | 28   | 25  | 26  | 24   | —  | —  | —   | —  |
| Temperature range for use °C                       | -50 to +250  | -50 to +260  | -50 to +260   | -20 to +300   | -20 to +100  | -50 to +160  | -50 to +160  | -50 to +200   | -20 to +125  |
| Supplied cable                                     | VP-51LB (2 m)  | VP-51B (2 m)   | VP-51B (2 m)  | VP-51I (1 m)  | Direct-mount cable 5 m<br>(no connector)   | VP-51C (2 m)   | VP-51Lx3 (2 m)   | VP-51WL (2 m)   | VP-51W (3 m)   |
| Dimensions mm                                      |                   |                   |                  |                  |                   |                  |                   |                  |                   |

<sup>\*1</sup> Representative value. Actual values are given on calibration sheet supplied with accelerometer. <sup>\*2</sup> Representative value when mounted on flat surface with standard mounting method.

<sup>\*3</sup> To extend cable run, VP-52A and VP-51A are required. <sup>\*4</sup> Max. 100 °C, max. 1000 m/s<sup>2</sup> <sup>\*5</sup> 1 Hz to 2 Hz (±15 %) at 150 °C to 170 °C <sup>\*6</sup> 0.6 Hz to 20 kHz (±20 %), 0.5 Hz to 20 kHz (±30 %)

**Note** ● The piezoelectric element in a piezoelectric accelerometer may be damaged by excessive shock. Take care not to drop the accelerometer, and handle it with care when using the magnetic attachment.

### Attachments

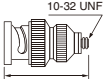
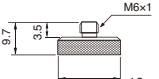
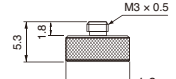
|                               |   |                                     |   |                                     |   |
|-------------------------------|---|-------------------------------------|---|-------------------------------------|---|
| <b>BNC Adapter<br/>VP-52C</b> |  | <b>Magnet Attachment<br/>VP-53S</b> |  | <b>Magnet Attachment<br/>VP-53T</b> |  |
|-------------------------------|---|-------------------------------------|---|-------------------------------------|---|

**For active control systems sensor applications**

**Servo Accelerometer LS-40C**



**Servo Accelerometer LS-10C**



- Capable of measurement in the ultra-low frequency range from gravitational acceleration (DC) to about 100 Hz with flat frequency response
- Sensitivity and phase characteristics remain flat down to DC, suitable for seismographic measurements as well as measurements on large structures in control systems, architecture, civil engineering, and machine tool applications
- Dedicated power supply LF-20 enables direct connection of accelerometer output to FFT analyzer, data recorder or similar device
- LS-10C can be directly connected to Vibration Meter VM-83

**Specifications LS-40C**

|  |  |
|--|--|
| Maximum measurable acceleration          | ±20 m/s <sup>2</sup>   |
| Voltage sensitivity                      | 0.5 V/(m/s <sup>2</sup> ) ±1 % (DC)                          |
| Measurement frequency range              | DC to 100 Hz (±10 %)   |
| Power supply voltage                     | ±15 V DC (±11 V to ±18 V)                                    |
| Temperature/humidity range for operation | -20 °C to +60 °C, max. 85 %RH                                |
| Dimensions, Weight                       | 37 (H) x 37 (W) x 40 (D) mm, approx. 230 g (including cable) |

**Specifications LS-10C**

|  |  |
|--|--|
| Maximum measurable acceleration          | ±30 m/s <sup>2</sup>   |
| Voltage sensitivity                      | 0.3 V/(m/s <sup>2</sup> ) ±1 % (DC)                          |
| Measurement frequency range              | DC to 100 Hz (±10 %)   |
| Power supply voltage                     | ±15 V DC (±11 V to ±18 V)                                    |
| Temperature/humidity range for operation | -20 °C to +60 °C, max. 85 %RH                                |
| Dimensions, Weight                       | 37 (H) x 37 (W) x 40 (D) mm, approx. 220 g (including cable) |

**Servo Accelerometer Power Supply LF-20**



- Dedicated power supply for servo accelerometers
- Continuous operation with three LS-40C units approx. 50 hours, with three LS-10C units approx. 100 hours (using alkaline batteries)

**Specifications**

|                    |  |
|--------------------|--|
| Supplied voltage   | ±15 V  |
| Output sensitivity | Using LS-40C 0.5 V/(m/s <sup>2</sup> )<br>Using LS-10C 0.3 V/(m/s <sup>2</sup> ) |
| Power              | Six IEC R20 (size D) batteries, AC adapter (NC-99A, option)                      |
| Dimensions, Weight | 140 (H) x 240 (W) x 120 (D) mm, approx. 2.7 kg                                   |

**Reference accelerometer for comparative calibration of various accelerometers**

**Reference Piezoelectric Accelerometer PV-03**



- Specially designed piezoelectric element and internal construction assure high resistance to external noise, unlike other compression type accelerometers. Flat response and excellent thermal characteristics are assured.
- Only reference accelerometer made in Japan capable of using the back to back principle for comparative calibration with a wide range of accelerometers

**Specifications**

|                                 |   |
|---------------------------------|---|
| Charge sensitivity              | 0.47 pC/(m/s <sup>2</sup> ) (80 Hz)   |
| Measurement frequency range     | 20 Hz to 1 000 Hz (±1 %), 5 Hz to 10 000 Hz (+10, -1 %)                     |
| Maximum measurable acceleration | 5 000 m/s <sup>2</sup>  |
| Dimensions, Weight              | Approx. 16 (hexagonal width across flats) x approx. 29 (H) mm, approx. 38 g |

**For calibration of accelerometers and vibration meters on-site**

**Calibration Exciter VE-10**



- Single-frequency (sine wave) reference vibration source for calibrating piezoelectric accelerometers and vibration meters or vibration measurement systems using accelerometers
- Small size and light weight make the unit easy to carry, and battery powered operation is convenient for mobile use
- Servo circuit enables calibration of accelerometers of up to 70 grams

**Specifications**

|                      |  |
|----------------------|--|
| Exciter frequency    | 159.2 Hz ±1 %  |
| Exciter acceleration | 10 m/s <sup>2</sup> (rms) ±3 %                                 |
| Exciter velocity     | 10 mm/s (rms) ±4 %   |
| Exciter displacement | 10 μm (rms) ±5 %   |
| Dimensions, Weight   | Approx. dia.51x134 (H) mm, approx. 600 g (including batteries) |

**For dynamic force measurements**

**Force Sensor PF-31**



- Designed for connection to charge amplifier for dynamic force measurements
- Converts force acting on quartz element into an electrical signal
- Small dimensions, light weight, sturdy construction

**Specifications**

|                             |   |
|-----------------------------|---|
| Charge sensitivity          | 4 pC/N (80 Hz)  |
| Measurement frequency range | 2 Hz to 10 000 Hz (±1 dB)   |
| Measurable force range      | 0.01 N to 5 000 N   |
| Dimensions, Weight          | Approx. 18 (hexagonal width across flats) x approx. 15 (H) mm, approx. 23 g |

**For mechanical impedance measurements**

**Impedance Head PF-60A**



- Integrated accelerometer and force pickup configured as impedance head
- Unit is inserted between vibrator and specimen, and excitation is applied. Signals from accelerometer and force pickup are input to an analyzer for determining mechanical impedance.

**Specifications**

|                                 |   |
|---------------------------------|---|
| Charge sensitivity              | Accelerometer 3.20 pC/N (80 Hz)<br>Force sensor 260 pC/N (80 Hz)            |
| Measurement frequency range     | 1 Hz to 10 000 Hz (±1dB)  |
| Maximum measurable acceleration | 5 000 m/s <sup>2</sup>  |
| Maximum measurable force        | 1 000 N   |
| Dimensions, Weight              | Approx. 16 (hexagonal width across flats) x approx. 32 (H) mm, approx. 37 g |

**For extension between accelerometer and vibration meter**

**Vibration Meter Preampifier VP-26A**



- Prevents sensitivity degradation by accelerometer cable
- Prevents increase in external noise
- Suitable for low-output accelerometers

**Specifications**

|                 |                   |
|-----------------|-------------------|
| Sensitivity     | 1 mV/pC           |
| Frequency range | 0.16 Hz to 30 kHz |

**Extension examples**



**Support for CCLD (Constant Current Line Drive)**

**Charge Converter VP-40**



- Simplifies the configuration of a vibration measurement system using a piezoelectric accelerometer with charge output

**Specifications**

|                 | VP-40                  | VP-42                  |
|-----------------|------------------------|------------------------|
| Gain            | 1 mV/pC ±2.5 % (80 Hz) | 1 mV/pC ±2.5 % (80 Hz) |
| Frequency range | 1 Hz to 30 kHz (±5 %)  | 1 Hz to 30 kHz (±5 %)  |

**Charge Converter VP-42**



**Connection example**

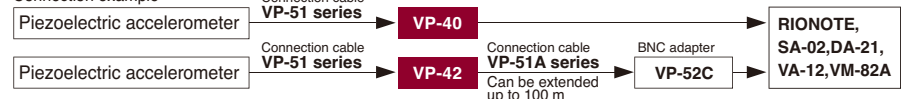

# Vibration

**Simultaneous measurement of multiple parameters including PPV and VDV**  
**Simultaneous calculation of the measurement quantities defined by DIN 45669-1, ISO 8041 and other international standards**



## Tri-axial Groundborne Vibration Meter VM-56



- PPV VDV** Simultaneous measurement of multiple parameters including PPV and VDV.
- User definable PPV vs Frequency comparator** output supports DIN 4150: Part 3 and other frequency-dependent PPV building damage criteria.
- Simultaneous tri-axial measurement.** Compact and lightweight design.
- Flexible product configuration** with waveform recording function and 1/3 octave band analysis function available as optional programs.
- Data stored as CSV files** on an SD card.
- Suitable for use in a live-to-web system** (please contact us for further details).

### Specifications

|  |  |                    |              |
|--|--|--------------------|--------------|
| Applicable standards                                 | DIN 45669-1: 2010-09 (Frequency, Measurement range compliance), SBR Meten en beoordelen van trillingen, Deel A: Schade aan gebouwen 2010, Deel B: Hinder voor personen 2013, ISO 8041: 2005, ISO 8041-1: 2017, CE marking, WEEE directive  |                    |              |
| Measurement functions                                | Tri-axial simultaneous measurement   |                    |              |
| Measurement values                                   |  |                    |              |
| In accordance with DIN                               | Peak particle velocity $ v _{max}$ (PPV)<br>Dominant frequency $f_{mg}$ (D.F.)<br>Weighted vibration maximum value $KB_{Fmax}$<br>Maximum $KB_F$ value over 30-second $KB_{FT}$  |                    |              |
| In accordance with ISO                               | Corrected acceleration effective value $Acc.$<br>Maximum transient vibration value $MTVV$<br>Vibration dose value $VDV$<br>Crest factor $C.F.$   |                    |              |
| In accordance with SBR                               | Maximum weighted vibration value $V_{eff,max}$<br>Maximum $v_{eff}$ over 30-second cycle $V_{eff,max,30}$  |                    |              |
| Others   | Displacement (0-p value) $Disp.$<br>Combined PPV for 3 axes $PVS$  |                    |              |
| Waveform recording (Option)                          | Time waveform of acceleration signal $a(t)$  |                    |              |
| 1/3 octave band analysis value (Option)              | Time-weighted time average, maximum acceleration<br>Band maximum OA for 3 axes combined $Law$  |                    |              |
| Measurement frequency range                          | 0.5 Hz to 315 Hz   |                    |              |
| Measurement range                                    | Measurement frequency setting is 1 to 80 Hz, defining the following range  |                    |              |
| Measurement range for VM-56                          | Vibration velocity: 0.03 to 100 mm/s<br>Weighted vibration amount: 0.02 to 100 mm/s (Reference 16 Hz)<br>Maximum absolute waveform value: 0.05 to 100 mm/s (Reference 16 Hz)<br>Vibration acceleration: 0.0003 to 10 m/s <sup>2</sup><br>Displacement (0-p): 0.01 to 10 mm (0.5 to 4 Hz)<br>Measurement range compliant with SBR-Deel B<br>Vibration velocity: 0.02 to 100 mm/s (Frequency bandwidth 1 to 80 Hz) |                    |              |
| Store modes  | 3 modes (Manual, Auto, Timer Auto), Data format: CSV   |                    |              |
| Power requirements                                   | IEC R6 (size AA) battery x 8 or external power supply  |                    |              |
| Battery life   | 24 hours or more, constant operation *Battery life will differ depending on settings.  |                    |              |
| AC adapter   | NC-98E   |                    |              |
| Dimensions, weight                                   | Approx. 175 mm (H) x 175 mm (W) x 40 mm (D) mm, approx. 780 g (incl. batteries)  |                    |              |
| Accelerometer  | Rated sensitivity: 60 mV/(m/s <sup>2</sup> )   |                    |              |
| Tri-axial  | Frequency range: 0.5 Hz to 315 Hz  |                    |              |
| Accelerometer PV-83D                                 | Usage temperature range: -20 °C to +60 °C (no condensation)<br>Waterproofing: IPX7   |                    |              |
| (Cable: 1.5 m)                                       | Dimensions and weight: Approx 67 mm (dia.) x 50.5 mm (D), approx. 450 g  |                    |              |
| Options  |  |                    |              |
| Waveform recording program                           | VX-56WR  | AC adapter         | NC-98E       |
| 1/3 octave band analysis program                     | VX-56RT  | 7P Extension Cable | EC-04 series |
| Waveform Analysis Software for Groundborne Vibration | AS-70GV  | DIN plate          | VP-54D       |
| SD card (512 MB, 2 GB, 32 GB)                        |  | L-bracket          | VP-54L       |

## Waveform Recording Program VX-56WR

Allows recording vibration waveforms on SD card as WAV files. The recording process is carried out simultaneously with the standard VM-56 functions.

|  |                 |                  |                   |
|--|-----------------|------------------|-------------------|
| 2 kHz sampling with 24 bit or 16 bit can be selected |                 |                  |                   |
| Max. recording time (at 16 bit)                      |                 |                  |                   |
| Memory card  | 512 MB          | 2 GB             | 32 GB             |
| Sampling frequency                                   | Approx. 6 hours | Approx. 27 hours | Approx. 470 hours |
| 2 kHz  |                 |                  |                   |

## 1/3 Octave Band Analysis Program VX-56RT

Enables measurement and logging of 1/3 octave acceleration levels simultaneously with broadband parameters (e.g. PPV, dominant frequency, VDV, MTVV). Can be used concurrently with VX-56WR.

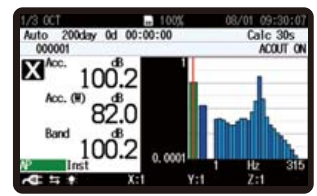

1/3 Octave Band Analysis screen

## Waveform Analysis Software for Groundborne Vibration AS-70GV

Allows use of WAV files recorded with VM-56 + VX-56WR for graph display, level processing, frequency analysis (octave band analysis / FFT analysis), recalculation (PPV, KB, VDV), and file output.

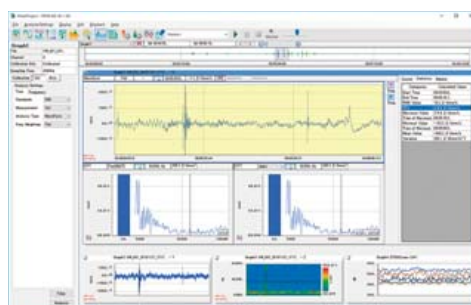

## Mounting options

**DIN Plate VP-54D**



**L-bracket VP-54L**





**Vibration Level Meter compliant with the Japan Measurement Act, JIS C 1510: 1995 and JIS C 1517: 2014 and Korea Vibration Measurement Act. Vibration evaluation using Vibration Criterion (VC) at precision machinery installation such as semiconductor manufacturing equipment**

\* Optional program NX-43RT is required



**Vibration Level Meter VM-57 CE**



Designated manufacturer of special measurement instrument  
Designation number: 351301



**Specifications**

|                             |   |
|-----------------------------|---|
| Applicable standards        | Vibration Level Meter compliant with the Japan Measurement Act<br>JIS C 1510: 2023, JIS C 1517: 2014,<br>CE Marking (EMC Directive, Low Voltage Directive, RoHS Directive),<br>WEEE Directive, China RoHS, KC mark  |
| Measurement functions       | 1 direction (Z) or simultaneous measurement in 3 directions (XYZ)<br>Vibration level $L_v$ and vibration acceleration level $L_{va}$<br>Maximum value hold for vibration level and vibration acceleration level   |
| Calculation measurement     | Equivalent continuous level of vibration level and vibration acceleration level $L_{eq}$<br>Percentile levels of vibration level and vibration acceleration level $L_5, L_{10}, L_{50}, L_{90}, L_{95}$<br>Maximum value of vibration level and vibration acceleration level $L_{max}$<br>Minimum value of vibration level and vibration acceleration level $L_{min}$ |
| Measurement frequency range | Vibration level : 1 Hz to 80 Hz,<br>Vibration acceleration level : 1 Hz to 80 Hz  |
| Measurement level range     | Vertical direction of vibration level: 25 dB to 129 dB, Horizontal direction of vibration level: 30 dB to 122 dB, Vibration acceleration level: 30 dB to 129 dB   |
| Store modes                 | Manual, Auto*, Timer Auto*  |
| Power supply                | AA batteries (x8) or external power source,<br>AC adapter (Option: NE-21P), Battery pack (Option: BP-21A)   |
| Dimensions, weight          | Approx. 150.5 mm (H) × 173.2 mm (W) × 44.0 mm (D)), 1,110 g (including main unit, 3-axis accelerometer PV-83E, connection cable EC-54S, and batteries)  |

\* VX-57EX required separately

**Options**

|                              |          |
|------------------------------|----------|
| Memory Card (512 MB SD card) | MC-51SD1 |
| Memory Card (2 GB SD card)   | MC-20SD2 |
| Memory Card (32 GB SD card)  | MC-32SP3 |

- Newly equipped with a LAN port to enhance connection with communication devices and to networks
- Can be powered by a commercially available mobile battery via a USB Type-C port to allow extended measurements even at sites without access to power outlets
- Simultaneous measurement of vibration level ( $L_v$ ), and vibration acceleration level ( $L_{va}$ )
- Optional program VX-57RT allows easy evaluation based on VC curve\*

\* VC curve is used as a method of evaluation that specifies the minimum vibration criteria for proper machine operation

**Specifications**

|  |   |
|--|---|
| Triaxial Accelerometer PV-83E (supplied) | Sensitivity: 60 mV (m/s <sup>2</sup> ),<br>Temperature range for operation: -10°C to +50°C,<br>Dimensions, weight: Approx. dia 67 × 41 (H) mm,<br>Approx. 300 g |
|--|---|

**Extended Function Program VX-57EX**



After installation, the card can be used as a 512 MB SD memory card.

\* Once installed, the VX-57EX cannot be uninstalled.

The VX-57WR and VX-57RT can be added by installing the VX-57EX.

**VX-57EX** → **Added function** Auto store function (simultaneous and continuous recording of instantaneous values and processing values)  
LAN function / four types of marker function / comparator function / continuous data output function (serial communication)

**VX-57WR** → **Added function** Vibration waveform recording

**VX-57RT** → **Added function** 1/3 octave real-time analysis / 1/3 octave band filter output / VC value measurement function

**Waveform Recording Program VX-57WR**

Allows simultaneous vibration level processing and waveform recording. Recorded data can be analyzed on a computer to perform frequency analysis. (Saved as non-compressed WAVE files)



After installation, the card can be used as a 2 GB SD memory card.

Sampling at 1 kHz, 24-bit or 16-bit selectable

Maximum recording time (when set to 3-axis, auto store, 16-bit,  $L_v$  store cycle of 100 ms)

| Memory card              | 512 MB           | 2 GB             | 32 GB             |
|--------------------------|------------------|------------------|-------------------|
| Added function           |                  |                  |                   |
| Sampling Frequency 1 kHz | Approx. 14 hours | Approx. 57 hours | Approx. 880 hours |

**1/3 Octave Real-time Analysis Program VX-57RT**

Allows real time 1/3 octave band analysis. Saved analysis results can be read for viewing.



After installation, the card can be used as a 512 MB SD memory card.

1/3 octave band analysis screen (simulated image)

**Adds support for handling data measured with VM-57 to AS-60**

**Data Management Software for Environmental Measurement (Includes the vibration level data management software)**

**AS-60VM**

Supported models

■ VM-57/55/53A \* \* Auto store data only

See p. 9 for AS-60 specifications

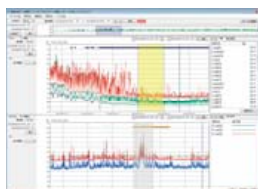

**Adds support for handling data measured with VM-57 + VX-57EX + VX-57RT to AS-60**

**Data Management Software for Environmental Measurement (Includes the 1/3 octave data vibration level data management software)**

**AS-60VMRT**



Acoustics

Vibration

Frequency Analysis

Recording

Related Products

Measuring Instrument Contributions  
External view drawings

Outline

Knowledge in a Nutshell

Company Outline

# Vibration

Signal outputs for 3 directions allow connection of frequency analyzer and waveform recording on data recorder

## 3-Axis Vibration Meter VM-54 CE



- Can be used with a variety of accelerometers and vibration pickups to configure a 3-axis acceleration measurement system
- Various modes can be implemented by installing the respective software from program cards

| Specifications                                |   |
|---|---|
| Inputs  | 3 channels (with 3-channel vibration input preamplifier)          |
| Measurement frequency range                   | 0.5 Hz to 5 000 Hz  |
| Measurement mode (instantaneous 3-axis value) | Acceleration $m/s^2$  |
| Outputs                                       | Separate AC outputs for 3-axis signals                            |
| Power   | Four IEC R14 (size C) batteries, continuous operation 16 hours    |
| Temperature/humidity range for operation      | -10 °C to +50 °C, max. 90 %RH                                     |
| Dimensions, Weight                            | 56 (H) × 200 (W) × 175 (D) mm, approx. 1 kg (including batteries) |

## FFT Analysis Card VX-54FT



Sub screen

- Functions as a memory card and allows storing FFT analysis result data in CSV format
- Supplied Excel macro makes it easy to generate a graph display from stored data (VX-54WS, VX-54WB, VX-54WH FFT analysis also supported)

## 3-ch Preamplifier VP-80



| Specifications     |   |
|--------------------|---|
| Input selection    | Switch-selectable input (for 3 channels together)   |
| Available settings | Charge amplifier x1:<br>Sensitivity 1 mV/pC<br>Charge amplifier x1/10:<br>Sensitivity 0.1 mV/pC<br>CCLD |

| Specifications       |  |
|----------------------|--|
| Display items        | 1. FFT processed spectrum display<br>2. Effective value (O.A.) calculated from time domain<br>3. O.A. value* calculated from frequency domain (FFT result)<br>*Partial overall value for specified frequency range can also be calculated. |
| Display functions    | Dependent on respective program card   |
| Measurement channels | X, Y, Z (3 channels simultaneous analysis)   |
| Window types         | Hanning, Rectangular   |
| Analysis lines       | 400  |
| Processing           | Instantaneous value, RMS method, maximum value   |
| Data store function  | Manual store on VX-54FT card<br>3-channel FFT spectrum data stored in CSV format<br>Max. 100 data sets per file (3-channel data form 1 set)<br>Max. 50 files   |

## Vibration measurement system for evaluating comfort in passenger vessels and merchant vessels

### Marine Vibration Card VX-54WS



- Measure and evaluate vibrations occurring in crew and passenger accommodation sections of ships, to evaluate suitability and comfort according to ISO 20283-5: 2016, JIS F 0907
- Measurement system for marine vibrations consists of Triaxial Accelerometer PV-83CW (for floor positioning, supplied), 3-Axis Vibration Meter VM-54, and Marine Vibration Card
- Measurement data can be stored on memory card (CF card)

| Specifications              |  |
|-----------------------------|--|
| Applicable standards        | ISO 20283-5: 2016, JIS F 0907: 2003  |
| Input                       | Piezoelectric Accelerometer PV-83CW (triaxial), Piezoelectric Accelerometer PV-57A (single axis, option) |
| Measurement frequency range | 1 Hz to 80 Hz (with FLAT characteristics of PV-57A up to 1 kHz)  |
| Frequency weighting         | Wm (ISO 2631-2: 2003, bandwidth limiting characteristics)  |
| Processing functions        | RMS, max (MTVV), min   |
| Measurement time settings   | 10 sec, 1 min, 2 min, 10 min   |

\* Power requirements, temperature/humidity range for operation, dimensions and weight same as for VM-54

### PV-83CW CE (supplied)

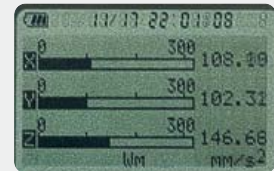

Graphic screen

## Evaluate vibrations affecting the whole body

### Whole Body Vibration Card VX-54WB1



- Measure and evaluate vibrations as specified in ISO 2631 and JIS B 7760 regarding vibration perception
- Whole-body vibration measurement system consists of Seat Measurement Accelerometer PV-62, 3-Axis Vibration Meter VM-54, and Whole Body Vibration Card
- Measurement data can be stored on memory card (CF card)

| Specifications              |  |
|-----------------------------|--|
| Applicable standards        | ISO 2631-1: 1997, ISO 2631-2: 2003, ISO 8041: 2005, JIS B 7760-1: 2004, JIS B 7760-2: 2004               |
| Input                       | Seat Accelerometer PV-62 (triaxial), Piezoelectric Accelerometer PV-83CW (triaxial)                      |
| Measurement frequency range | 0.5 Hz to 80 Hz  |
| Frequency weighting         | Wk, Wd, Wb, Wc, Wj, Wm, Wg, bandwidth limiting characteristics   |
| Processing functions        | RMS, MTVV, VDV, Synthesized Value, PEAK, Crest Factor  |
| Measurement time settings   | 1 sec to 30 sec in 1-sec units 1 min, 10 min, 30 min, 1 hour, 4 hours, 8 hours, 12 hours (max. 12 hours) |

\* Power requirements, temperature/humidity range for operation, dimensions and weight same as for VM-54

## Disc-shaped tri-axial accelerometer for whole-body vibration measurement and evaluation according to ISO 2631

### Seat Accelerometer PV-62 CE



| Specifications              |   |
|-----------------------------|---|
| Number of components        | 3 axes  |
| Charge sensitivity          | 3.5 pC/( $m/s^2$ ) (16 Hz)                          |
| Measurement frequency range | 1 Hz to 100 Hz ( $\pm 0.5$ dB)                      |
| Dimensions, Weight          | Approx. dia. 210 x approx. 12 (H) mm, approx. 400 g |

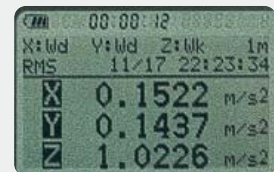

Numeric screen

## Evaluate vibrations transmitted through hands and arms

### Hand-Arm Vibration Card VX-54WH



- Measure and evaluate exposure to hand-arm vibrations as specified in ISO 5349-1, ISO 5349-2, JIS B 7761-1, JIS B 7761-2
- Hand-arm vibration measurement system consists of Accelerometer PV-97C, 3-Axis Vibration Meter VM-54, and Hand-Arm Vibration Card VX-54WH
- Measurement data can be stored on memory card (CF card)

| Specifications              |  |
|-----------------------------|--|
| Applicable standards        | ISO 5349-1: 2001, ISO 5349-2: 2001, ISO 8041: 2005, JIS B 7761-1: 2004, JIS B 7761-2: 2004, JIS B 7761-3: 2007 |
| Input                       | Piezoelectric Accelerometer PV-97C/97I (triaxial), etc   |
| Measurement frequency range | 8 Hz to 1 000 Hz   |
| Frequency weighting         | Wh   |
| Processing functions        | RMS, MTVV, VDV, Synthesized Value, PEAK, Crest Factor  |
| Measurement time settings   | 1 sec to 30 sec in 1-sec units 1 min, 10 min, 30 min, 1 hour, 4 hours, 8 hours, 12 hours (max. 12 hours)       |

\* Power requirements, temperature/humidity range for operation, dimensions and weight same as for VM-54

### PV-97C CE



### PV-97I



For specifications, see page 22.



FFT screen (using VX-54FT)

## Monitor machine vibrations in power stations, industrial plants, or production facilities

### Vibration Monitor UG-50

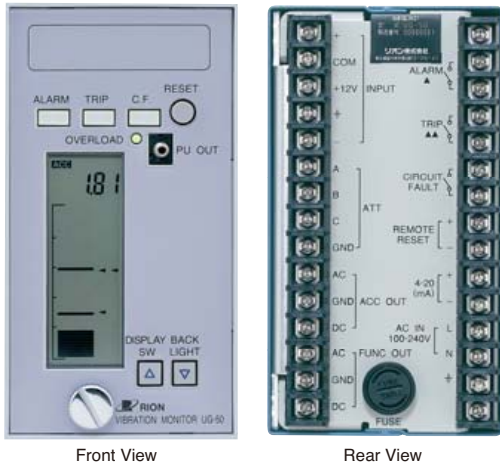

Front View

Rear View

- Suitable for constant monitoring of machine vibrations in power stations, industrial plants, or production facilities, using piezoelectric accelerometers
- Separate main monitoring circuit (switchable to acceleration, velocity, displacement mode) and dedicated acceleration circuit. This allows combination of vibration measurement and monitoring tasks.
- Separate alarm and trip threshold vibration levels can be set for main circuit, to trigger suitable actions when levels are exceeded
- High-pass filter and low-pass filter settings can be made separately for main circuit and acceleration circuit

#### Specifications

|   |  |   |          |   |              |       |
|---|--|---|----------|---|--------------|-------|
| Input switching   | Unbalanced input 1   | For piezoelectric accelerometer with integrated preamplifier                            |          |   |              |       |
|   | Unbalanced input 2   | For unbalanced connection via UG-20 or UG-21  |          |   |              |       |
|   | Balanced input   | For balanced connection via UG-20 or UG-21  |          |   |              |       |
| Monitoring modes  | Acceleration (m/s <sup>2</sup> )                                     | EQ PEAK (EQ PEAK= $\sqrt{2}$ ×RMS)  |          |   |              |       |
|   | Velocity (mm/s)  | RMS   |          |   |              |       |
|   | RMS Displacement (mm)  | EQ P-P (EQ P-P= $2\sqrt{2}$ ×RMS)   |          |   |              |       |
| Measurement frequency range                                 | Acceleration   | 5 Hz to 30 kHz  |          |   |              |       |
|   | Velocity   | 5 Hz to 2 kHz   |          |   |              |       |
|   | Displacement   | 5 Hz to 100 Hz  |          |   |              |       |
| Filters (main circuit)                                      | HPF  | Off (5 Hz), 10 Hz, 30 Hz, 50 Hz, 500 Hz (-3 dB)   |          |   |              |       |
|   | LPF  | Off (30 kHz), 50 Hz, 100 Hz, 500 Hz, 2 kHz (-3 dB)                                      |          |   |              |       |
| Filters (acceleration circuit)                              | HPF  | Off (5 Hz), 10 Hz, 30 Hz, 50 Hz, 500 Hz (-3 dB)   |          |   |              |       |
|   | LPF  | Off (30 kHz), 50 Hz, 100 Hz, 500 Hz, 2 kHz (-3 dB)                                      |          |   |              |       |
| DC output voltage   |  | +10 V (at range full-scale point)   |          |   |              |       |
| AC output voltage   |  | Acceleration 2 Vpeak Velocity 2 Vrms<br>Displacement 2 Vp-p (at range full-scale point) |          |   |              |       |
| Alarm functions   |  | Alarm, trip, circuit fault  |          |   |              |       |
| Alarm output  |  | Relay contacts close when alarm is triggered, and alarm LED lights up                   |          |   |              |       |
| Level range (main circuit, dedicated acceleration circuit)* | Relation between dedicated acceleration range and main circuit range | Main circuit  |          | Dedicated acceleration range (Range depends on setting range of main circuit) |              |       |
|   |  | Acceleration  | Velocity |   | Displacement |       |
|   |  | 1 000   | 1 000    |   | 100          | 1 000 |
|   |  | 300   | 300      |   | 30           |       |
|   |  | 100   | 100      |   | 10           | 100   |
|   |  | 30  | 30       |   | 3            |       |
|   |  | 10  | 10       |   | 1            | 10    |
| 3   | 3  | 0.3   |          |   |              |       |
| 1   | 1  | 0.1   | 1        |   |              |       |
| Power   | Input voltage range  | 85 V to 265 V AC, 47 Hz to 440 Hz   |          |   |              |       |
| Temperature/humidity range for operation                    |  | -10 °C to 50 °C, max. 90 %RH  |          |   |              |       |
| Dimensions, Weight  |  | Approx. 148 (H) x 80 (W) x 235 (D) mm, approx. 1.5 kg                                   |          |   |              |       |

\*When input charge for preamplifier UG-24 is set to 10 000 pC or higher, the above level range figures must be multiplied by 10.

### For enhanced connection flexibility between piezoelectric accelerometer and vibration monitor



#### Pre-amplifier UG-20

Charge amplifier for cable runs up to 300 meters



#### Pre-amplifier UG-21

Junction box preamplifier for cable runs up to 400 meters

#### 4-20 mA Isolation Unit UG-33

4-20 mA current output  
\* Factory option

#### Rack Mount Panel UG-90





For mounting of up to 5 units

Adds one user-definable high-pass filter and low-pass filter to main circuit

#### User Filter NX-50

- HPF: Setting range 3.15 Hz to 500 Hz, 1/3 octave band steps (Velocity, displacement HPF: setting range 6.3 Hz to 500 Hz)
- LPF: Setting range 50 Hz to 10 kHz, 1/3 octave band steps

### Piezoelectric Accelerometers

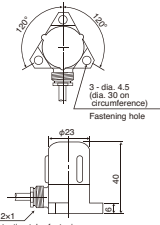
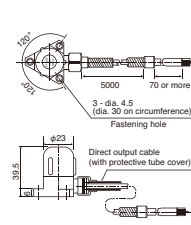
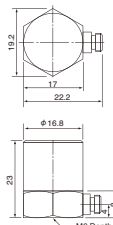
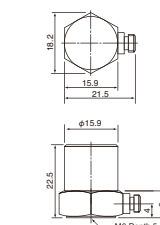
| External view and features                               |  Waterproof, insulated accelerometer with integrated preamplifier<br><b>PV-10B</b> |  Waterproof, insulated accelerometer<br>(For vibration measurements at nuclear power plants and similar; rated for gamma radiation resistance up to 1x10 <sup>6</sup> R)<br><b>PV-10T</b> |  Shear-type accelerometer with high temperature resistance, light weight, and high sensitivity (Radiation resistant, suitable for use at nuclear power plants under medium and high temperatures)<br><b>PV-63</b> CE |  For machine vibration measurements at high temperature<br><b>PV-65</b> CE |
|--|---|--|--|---|
| Charge sensitivity pC/(m/s <sup>2</sup> ) <sup>※1</sup>  | —   | 9.18   | 4.59   | 7.14  |
| Voltage sensitivity mV/(m/s <sup>2</sup> ) <sup>※1</sup> | 5.1   | —  | —  | —   |
| Measurement frequency range Hz <sup>※2</sup>             | 3 to 8 000 (±1 dB)<br>3 to 10 000 (±2 dB)   | 3 to 8 000 (±1 dB)<br>3 to 10 000 (±2 dB)  | 1 to 8 000 (±1 dB)<br>1 to 15 000 (±3 dB)  | 1 to 9 000 (±1 dB)  |
| Mounting resonance frequency kHz <sup>※2</sup>           | 24  | 24   | 26   | 25  |
| Temperature range for operation °C                       | -20 to +100   | -50 to +150  | -20 to +300  | -50 to +260   |
| Maximum measurable acceleration m/s <sup>2</sup> (peak)  | 500   | 2 000  | 4 000  | 4 000   |
| Standard mounting method <sup>※3</sup>                   | M4 screw (supplied) 1.5 N·m   | M4 screw (supplied) 1.5 N·m  | M6 screw (supplied with VP-56A) 3.5 N·m  | M6 screw (supplied with VP-56A) 3.5 N·m   |
| Waterproofing specifications                             | JIS C 0920<br>Protection class 8 (sealed), 2 atm  | JIS C 0920<br>Protection class 8 (sealed), 2 atm   | —  | —   |
| Cable  | Integrated type, 5 m (no connector)   | Integrated type, 5 m   | VP-51I (supplied)  | VP-51B (supplied)   |
| Mass g   | 120   | 120  | 28   | 26  |
| Dimensions (mm)  |    |   |   |    |

※1 Representative value; actual sensitivity as noted on calibration chart supplied with accelerometer    ※2 Representative value when using standard mounting method (※3) on flat surface

**Note** ● The piezoelectric ceramic element of these accelerometers can be damaged if subject to a strong shock. Take care not to drop the accelerometer, and use magnet attachments with care.

# Vibration

Simply press against the measurement object

## Pocketable Vibration Meter (RIOVIBRO)

VM-63C 



- Ultra compact vibration meter with integrated accelerometer. Weighs only 200 g and easily fits into a pocket.
- Designed for quick and easy use in the field
- Suitable for preventive maintenance of industrial equipment, on-site quality control, product development, and many other applications

### Specifications

|                    |   |   |
|--------------------|---|---|
| Measurement range  |   |   |
| Acceleration       |   | 0.1 to 199.9 m/s <sup>2</sup> EQ PEAK (RMS x $\sqrt{2}$ ) |
| Velocity           |   | 0.1 to 199.9 mm/s RMS                                     |
| Displacement       |   | 0.001 to 1.999 mm EQ P-P (RMS x $2\sqrt{2}$ )             |
| Display            | 3 1/2 digits, digital (LCD)   |   |
| Power supply       | IEC R6 (size AA) batteries (alkaline / manganese or nickel-hydride rechargeable batteries) x 2, About 50 h continuous use |   |
| Dimensions, weight | Approx. 178 (H) x 64 (W) x 27 (D) mm, approx. 200 g   |   |
| Options            |   |   |
| Attachment (L)     |   | VP-53Y  |
| Earphone           |   | VP-37   |

Convenient 3-mode measurement for acceleration, velocity, and displacement with storage capacity for up to 1 000 data

## General-Purpose Vibration Meter

VM-82A 



- Designed mainly for maintenance and inspection of industrial machinery, with particular emphasis on rotational machinery
- Acceleration, velocity, and displacement can be easily measured using a suitable frequency range, allowing comprehensive and precise evaluation of machine vibrations.

### Specifications

|                      |  |   |                         |
|----------------------|--|---|-------------------------|
| Measurement range    |  | (Using Shear-type Piezoelectric Accelerometer PV-57I, supplied) |                         |
| Acceleration         |  | 0.02 m/s <sup>2</sup> to 200 m/s <sup>2</sup>                   | EQ PEAK 1 Hz to 5 kHz   |
| Velocity             |  | 0.3 mm/s to 1 000 mm/s  | RMS 3 Hz to 1 kHz       |
|                      |  | 0.1 mm/s to 1 000 mm/s  | RMS 10 Hz to 1 kHz      |
| Displacement         |  | 0.02 mm to 100 mm   | EQ PEAK 3 Hz to 500 Hz  |
|                      |  | 0.001 mm to 100 mm  | EQ PEAK 10 Hz to 500 Hz |
| Output               | AC output, DC output   |   |                         |
| Power                | Four IEC R6 (size AA) batteries<br>AC adapter (NC-98E, option)                   |   |                         |
| Dimensions, Weight   | Approx. 171.5 (H) x 74 (W) x 25.5 (D) mm,<br>Approx. 270 g (including batteries) |   |                         |
| Options              |  |   |                         |
| Charge converter     |  |   | VP-40                   |
| Charge converter     |  |   | VP-42                   |
| BNC-RCA output cable |  |   | CC-24                   |

**Portable vibration analyzer for equipment diagnosis and on-site measurements**  
**Vibration Meter VA-12 with FFT analysis function**

**Vibration Analyzer**  
**VA-12** 



SD-CARD  
 **Memory card compatible model**

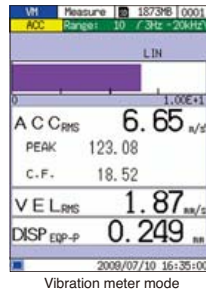

**Vibration Meter Mode**

- Allows simultaneous measurement of acceleration, velocity, displacement, and acceleration crest factor

**FFT Analyzer Mode**

- Real-time analysis frequency 20 kHz
- Time waveform display and spectrum display with up to 3 200 spectral lines. Envelope processing also supported.
- Vibration waveform data recording function (10 seconds at analysis frequency 20 kHz)
- Data stored in WAVE file format on memory card (SD card).
- Timer controlled automatic measurement

**Menu Mode**

- The color TFT display (240 x 320 dots) is easy to read, whether outdoors, indoors, or in a dark location.

**Specifications**

|   |  |
|---|--|
| Standard compliance   | CE marking (EMC Directive 2004/108/EC)<br>Chinese RoHS (export model for China only)<br>WEEE Directive |
| Input section   |  |
| Number of measurement channels  | 1  |
| Connector type etc.   | BNC, CCLD 18 V 2 mA, (CCLD24 V 4 mA available as factory option)                                       |
| Sensor  | Piezoelectric Accelerometer PV-57I (supplied)  |
| Input range   |  |
| At sensitivity 1.00 to 9.99 mV/(m/s <sup>2</sup> ), using PV-57I                |  |
| ACC (Acceleration)  | 1, 3.16, 10, 31.6, 100, 316, 1 000 m/s <sup>2</sup> (rms)  |
| VEL (Velocity)  | 3.16, 10, 31.6, 100, 316, 1 000, 3 160 mm/s (rms)  |
| DISP (Displacement)   | 0.089, 0.283, 0.894, 2.83, 8.94, 28.3, 89.4 mm (EQp-p)   |
| Measurement range (using PV-57I, High-pass filter 3 Hz, Low-pass filter 20 kHz) |  |
| ACC (Acceleration)  | 0.02 to 141.4 m/s <sup>2</sup> (rms) Continuous measurement, 1 Hz to 5 kHz                             |
| Instantaneous maximum acceleration  | 700 m/s <sup>2</sup>   |
| VEL (Velocity)  | 0.2 to 141.4 mm/s (rms) at 159.15 Hz   |
| DISP (Displacement)   | 0.02 to 40.0 mm (EQp-p) at 15.915 Hz   |
| Measurement frequency range (electrical characteristics)                        |  |
| ACC (Acceleration)  | 1 Hz to 20 kHz   |
| VEL (Velocity)  | 3 Hz to 3 kHz  |
| DISP (Displacement)   | 3 Hz to 500 Hz   |
| Acceleration envelope curve   | 1 kHz to 20 kHz  |
| Filters   |  |
| Prefilters  |  |
| High-pass filter  | 1 Hz (acceleration only), 3 Hz, 10 Hz, 1 kHz (±10 % point), cutoff slope -18 dB/oct                    |
| Low-pass filter   | 1 kHz, 5 kHz, 20 kHz (±10 % point), cutoff slope -18 dB/oct  |
| Acceleration envelope curve filter  |  |
| High-pass filter  | 1 kHz (±10 % point), cutoff slope -18 dB/oct   |
| Vibration meter mode  |  |
| ACC (Acceleration)  | m/s <sup>2</sup> rms value, waveform peak value, crest factor  |
| VEL (Velocity)  | mm/s rms value   |
| DISP (Displacement)   | mm EQp-p   |
| FFT mode  |  |
| Time waveform, spectrum, Acceleration envelope curve                            |  |
| Analysis points   | 512, 1 024, 2 048, 4 096, 8 192 (3 200 lines)  |
| Time window functions   | Rectangular, Hanning, Flat-top   |
| Processing  | Linear average, maximum, exponential averaging, instantaneous value                                    |
| Frequency span  | 100 Hz, 200 Hz, 500 Hz, 1 kHz, 2 kHz, 5 kHz, 10 kHz, 20 kHz  |

|                          |   |
|--------------------------|---|
| Trigger                  |   |
| Trigger source           |   |
| External signal          | Triggered at falling edge of signal at external trigger input   |
| Input level              | Triggered when time waveform crosses a preset level<br>Trigger level can be set in steps of 1/8 of full scale on one-sided amplitude          |
| Trigger operation        |   |
| Free-run                 | Processing always carried out, regardless of trigger condition  |
| Repeat                   | Processing carried out whenever triggering occurs   |
| Single                   | Processing carried out once only when triggering occurs   |
| Time                     | Data are stored according to the setting of Trigger Start Time, Store Interval, Store number.   |
| Memory                   |   |
| Memory media             | SD cards (max. 2 GB)*   |
| Store files              | Sets of measurement values and parameters can be stored on memory card<br>1 000 data saved as one store name. Max. number of store names: 100 |
| Parameter setting memory | Up to 5 parameter sets can be stored in unit<br>Parameter settings can be stored on memory card   |
| Wave files               | Up to 10 seconds per file (frequency range 20 kHz)<br>Vibration waveform recorded during FFT processing available when using a computer.      |
| BMP files                | Screen capture can be saved as BMP files.   |
| Recall function          | Measurement data can be read from memory card and redisplayed on screen.  |
| Input/output section     |   |
| Trigger input connector  | TTL level, BNC-mini plug, 2.5 mm dia. (for CC-24)   |
| USB port                 | Removable disk function<br>Removable storage device class   |
| Power                    |   |
| DC12 V (11 to 15 V)      | AC adapter NC-99A, eight IEC R6 (size AA) batteries   |
| Battery life             | Approx. 12 hours (23 °C, normal operation, backlight off)   |
| Dimensions, Weight       | 213 (H) x 105 (W) x 36 (D) mm (without protective cover), approx. 850 g (incl. batteries, with protective cover, PV-57I connected)            |

• Re-analysing is available on the computer.

**Options**

|                             |          |                  |          |
|-----------------------------|----------|------------------|----------|
| Wave Analysis Software      | AS-70    | Charge converter | VP-40    |
| Waveform Analysis Software  | CAT-WAVE | SD-CARD 512 MB*  | MC-51SS1 |
| Piezoelectric accelerometer | Various  | SD-CARD 2 GB*    | MC-20SS2 |
| BNC Adapter                 | VP-52C   |                  |          |

\*Use only RION supplied cards for assured operation

# Vibration

Flexible unit configuration allows simultaneous sound and vibration measurement

## Vibration Meter Unit UV-15



- Vibration Meter Unit UV-15 and Sound Level Meter Unit UN-14 can be linked in a measurement system with up to 16 channels
- Supports connection of piezoelectric accelerometers, accelerometers with integrated preamplifier, and TEDS compliant accelerometers
- Display shows parameters, measurement value, and bar graph indication
- Linking with Interface Unit UV-22 allows setup and control from a computer, and transfer of measurement values
- Backlit LCD and LED warning indicators
- Optional CF-27 base allows JIS standard rack mounting
- Can be powered from AC adapter or Battery Pack Unit BP-17

### Specifications

|                             |   |   |
|-----------------------------|---|---|
| Inputs                      | Microdot connector                                | For piezoelectric accelerometer (Maximum input charge 100 000 pC)   |
|                             | CCLD<br>(Constant Current Line Drive)             | Accelerometer with integrated preamplifier (24 V 4 mA)  |
|                             | 7-pin preamp connector<br>(Connector type PRC-03) | Accelerometer with TEDS compliant integrated preamplifier (24 V 4 mA)   |
| Measurement frequency range | Acceleration (ACC)                                | 1 Hz to 15 kHz (AC output tolerance $\pm 5\%$ ), 0.5 Hz to 30 kHz (AC output tolerance 10 %)  |
|                             | Velocity (VEL)                                    | 3 Hz to 3 kHz (AC output tolerance $\pm 5\%$ )  |
|                             | Displacement (DISP)                               | 3 Hz to 500 Hz (AC output tolerance $\pm 10\%$ )  |
| Filters                     | HPF (attenuation -18 dB/oct)<br>(-10 % drop)      | 3, 5, 10, 15, 20, 30, 50, 100, 150, 200 Hz, Off<br>(User filter supported with UV-22)   |
|                             | LPF (attenuation -18 dB/oct)<br>(-10 % drop)      | 300, 500, 1 k, 1.5 k, 2 k, 3 k, 5 k, 10 k, 15 k, 20 kHz, Off<br>(User filter supported with UV-22)  |
| Power                       |   | 9 V to 15 V DC, suitable AC adapter NC-99A, Battery Pack Unit BP-17, Cigarette plug adapter CC-82 (option, up to 16 units*)<br>*Depending on car battery capacity |
| Dimensions, Weight          |   | 150 (H) x 36 (W) x 179 (D) mm (not including protruding parts), approx. 500 g   |

### Options

|                             |         |                                 |                     |
|-----------------------------|---------|---------------------------------|---------------------|
| Piezoelectric accelerometer | Various | Vibration Meter Preamplifier    | VP-26A              |
| Accelerometer cable         | Various | Vibration Level Meter/Vibration | EC-02S (3 m and up) |
| BNC-BNC Cable               | NC-39A  | Accelerometer Cable             |                     |

Dedicated interface unit for UN-14 / UV-15

## Interface Unit UV-22



- USB and Ethernet interface provide flexible connectivity for controlling UN-14 and UV-15 units via commands sent from a computer
- Supplied UV-22Viewer software allows UN-14 and UV-15 setup, measurement value checking, and user-specified cutoff frequency setting for HPF and LPF (user filter\*) on the computer
- Master/Slave function simplifies measurement operation when multiple UN-14/UV-15 units are connected
- ※2-Channel Charge Amplifier UV-16 cannot be connected.
- \* Can be set in 1/3 octave band steps within the specified frequency range.

### Specifications

|  |   |
|--|---|
| Settings control (for UN-14 and UV-15)   | Input selection, sensitivity, HPF, LPF, user filter   |
| UN-14 only                               | Frequency weighting, level range, time weighting  |
| UV-15 only                               | Measurement mode, range, display characteristics  |
| Measurement values                       | UN-14: instantaneous value every 100 ms, maximum value, Peak, $L_{eq}$<br>UV-15: instantaneous value every 100 ms, maximum value, $\pm$ Peak                      |
| UN-14/UV-15 interface                    |   |
| Number of supported unit connections     | Up to a combined total of 16 UN-14/UV-15 units  |
| Computer interfaces                      |   |
| USB                                      | USB 1.1 (one UV-22 per computer supported)  |
| Connector                                | Mini B  |
| Ethernet                                 | 10/100 Base-TX (one UV-22 per computer supported)   |
| Temperature/humidity range for operation | -10 °C to 50 °C, max. 90 %RH  |
| Power                                    | 9 V to 15 V DC, suitable AC adapter NC-99A, Battery Pack Unit BP-17, Cigarette plug adapter CC-82 (option, up to 16 units*)<br>*Depending on car battery capacity |
| Current consumption                      | Approx. 240 mA (12 V DC, LAN operating)   |
| Dimensions, Weight                       | 150 (H) x 36 (W) x 179 (D) mm, approx. 500 g  |
| Supplied accessories                     | UV-22 Viewer software x 1 (CD-ROM), USB cable   |

## UV-22 Sound and Vibration Monitoring System CAT-UV22-MS

- The system enables you to monitor or record the time data for sound and Vibration that are measured by using UN-14 or UV-15.
- Up to 16 UN-14 or UV-15 units can be connected to UV-22, allowing you to use the system to perform multipoint measurements.



Graph (All Channel) tab



Configuration tab

Measure machine vibrations in power stations, industrial plants, or engines and motors during product development

## 2-Channel Charge Amplifier UV-16 CE



Front View

Rear View

- Designed for connection of piezoelectric accelerometers or accelerometers with integrated preamplifier
- Link the chassis of up to 16 units to create a multi-channel configuration with up to 32 channels
- JIS standard rack mounting supported (max. 12 units/24 channels)
- Can be powered from an AC adapter or Battery Pack BP-17

### Specifications

|                             |                     |  |
|-----------------------------|---------------------|--|
| Inputs                      |                     | Piezoelectric accelerometer<br>Accelerometer with integrated preamplifier (24 V 4 mA)  |
| Measurement frequency range | Acceleration (ACC)  | 1 Hz to 15 kHz (AC output tolerance $\pm 5\%$ )<br>0.5 Hz to 30 kHz (AC output tolerance $\pm 10\%$ )  |
|                             | Velocity (VEL)      | 3 Hz to 3 kHz (AC output tolerance $\pm 5\%$ )   |
|                             | Displacement (DISP) | 3 Hz to 500 Hz (AC output tolerance $\pm 10\%$ )   |
| Filters                     |                     | HPF 10 Hz, LPF 1 kHz compliant with JIS B 0907: 1989 frequency response compensation filter characteristics  |
|                             |                     | HPF OFF, 10 Hz, 20 Hz, 50 Hz   |
|                             |                     | LPF 1 kHz, 3 kHz, 10 kHz, OFF  |
| Power                       |                     | 9 V to 15 V DC, suitable AC adapter NC-99A, Battery Pack Unit BP-17, Cigarette plug adapter CC-82 (option, up to 16 units*)<br>* Depending on car battery capacity |
| Dimensions, Weight          |                     | 150 (H) $\times$ 36 (W) $\times$ 179 (D) mm (not including protruding parts), approx. 500 g  |
|                             |                     | Options  |
|                             |                     | Piezoelectric accelerometer Various  |
|                             |                     | Accelerometer cable Various  |
|                             |                     | BNC-BNC Cable NC-39A   |

Link to UV-15/UV-16/UN-14 to provide power for mobile measurement (Required one of sources listed below)

## Battery Unit BP-17 CE



Example for linkup with UV-15 units

- Battery power can be used to drive up to three units (AC adapter connection allows connection of 1 to 16 units)
  - Holds eight IEC R14 (size C) batteries
  - Continuous operation time: approx. 8 hours (with alkaline batteries, using UV-15/UN-14) approx. 17 hours (with alkaline batteries, using UV-16)
- \*3 linked units, ambient temperature 25 °C, with CHARGE setting, normal operation.  
Actual time will differ depending on ambient conditions and operation settings.

## AC Adapter NC-99A

- 100 V to 240 V AC, 12 V DC

## Rack Mounting Base CF-27 (JIS compliant)

- Dimensions: 149 (H)  $\times$  480 (W)  $\times$  320 (D) mm

Supports connection of Servo Accelerometer LS-10C for 3-mode measurement of acceleration, velocity, and displacement

## General-Purpose Vibration Meter VM-83 CE

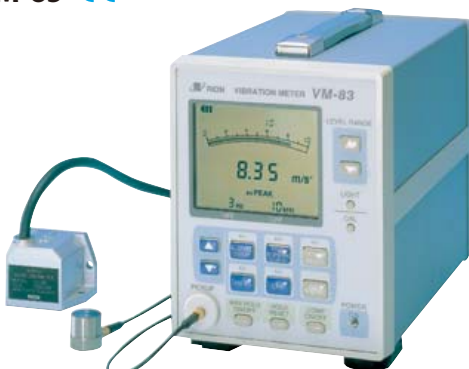











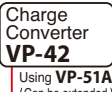









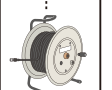
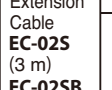

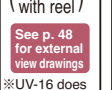



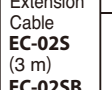

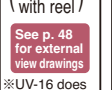





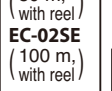
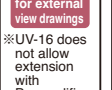
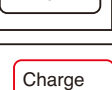
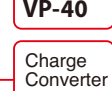
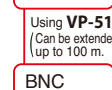
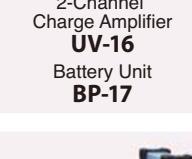





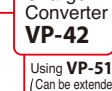









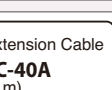
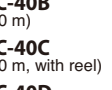
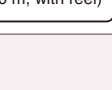





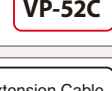
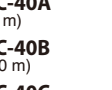
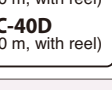





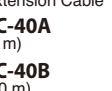
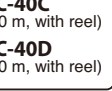

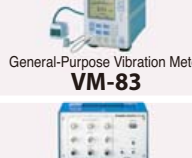
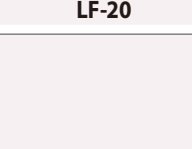

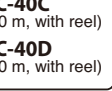
- Measure and evaluate vibrations using a piezoelectric accelerometer or the Servo Accelerometer LS-10C (With optional servo accelerometer LS-10C, even very low frequency vibrations from 0.1 Hz upwards can be measured.)
- Display characteristics can be switched to rms, equivalent peak, and equivalent peak-to-peak, with maximum value hold and peak hold capability

### Specifications

|                           |                             |  |   |
|---------------------------|-----------------------------|--|---|
| Vibration frequency range | Piezoelectric accelerometer | Acceleration   | 1 Hz to 20 kHz $\pm 5\%$                                  |
|                           |                             | Velocity   | 1 Hz to 3 Hz $\pm 10\%$ , 3 Hz to 3 kHz $\pm 5\%$         |
|                           |                             | Displacement   | 1 Hz to 3 Hz $\pm 20\%$ , 3 Hz to 500 Hz $\pm 10\%$       |
|                           | Servo accelerometer         | Acceleration   | 0.1 Hz to 100 Hz $\pm 5\%$                                |
|                           |                             | Velocity   | 0.1 Hz to 0.3 Hz $\pm 10\%$ , 0.3 Hz to 100 Hz $\pm 5\%$  |
|                           |                             | Displacement   | 0.1 Hz to 0.3 Hz $\pm 20\%$ , 0.3 Hz to 100 Hz $\pm 10\%$ |
| Power                     |                             | Four IEC R14 (size C) batteries, AC adapter (NC-98E, option) |   |
| Dimensions, Weight        |                             | 171 (H) $\times$ 120 (W) $\times$ 234 (D) mm, approx. 1.8 kg |   |
| Options                   |                             |  |   |
|                           |                             | Vibration level meter/vibration accelerometer cable          | EC-02S series (3 m and up)                                |
|                           |                             | Vibration Meter Preamplifier                                 | VP-26A  |
|                           |                             | Interface cable  | 5WKR4030  |

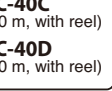
# Vibration

















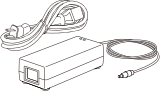



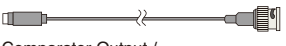

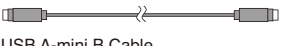

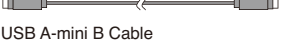



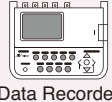
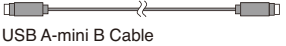





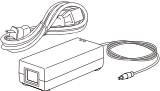

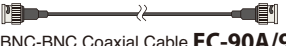
## Accelerometer Selection

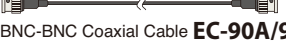
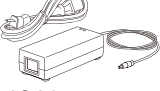
|                           | Piezoelectric Accelerometer   | Connection Cable   |  | Vibration Meter  |
|---------------------------|---|--|--|--|
| Standard piezoelectric    |  Piezoelectric Accelerometer <b>PV-03</b>    | Standard Cable <b>VP-51A</b>   |  Charge Converter <b>VP-42</b><br><small>Using VP-51A (Can be extended up to 100 m.)</small><br> BNC Adapter <b>VP-52C</b><br> Charge Converter <b>VP-40</b><br> BNC Adapter <b>VP-52C</b>   |  <b>VM-83</b><br>UV-15<br>UV-16<br><br> <b>SA-02</b><br>DA-21<br>RIONOTE |
|                           |  Piezoelectric Accelerometer <b>PV-90T</b>   | Ultra-compact Accelerometer Cable <b>VP-51LC</b> <small>*TEDS compliance only with UV-15</small> |  |  |
|                           |  Piezoelectric Accelerometer <b>PV-91C</b>   | Ultra-compact Accelerometer Cable <b>VP-51LC</b>   |  |  |
|                           |  Piezoelectric Accelerometer <b>PV-91CH</b>  | Ultra-compact Accelerometer Cable <b>VP-51LC</b>   |  |  |
| With integrated amplifier |  Piezoelectric Accelerometer <b>PV-85/86</b> | Standard Cable <b>VP-51A</b>   |  Pre-amplifier <b>VP-26A</b><br> Extension Cable <b>EC-02S</b> (3 m)<br> <b>EC-02SB</b> (10 m)<br> <b>EC-02SD</b> (50 m, with reel)<br> <b>EC-02SE</b> (100 m, with reel)<br><small>See p. 48 for external view drawings</small><br><small>※UV-16 does not allow extension with Pre-amplifier VP-26A</small>      |  <b>VM-83</b><br>UV-15<br><br> <b>UV-16</b>                             |
|                           |  Piezoelectric Accelerometer <b>PV-94/95</b> | Standard Cable <b>VP-51A</b>   |  |  |
| General-purpose           |  Piezoelectric Accelerometer <b>PV-08A</b>   | PV-08 Cable <b>VP-51J</b>  |  Pre-amplifier <b>VP-26A</b><br> Extension Cable <b>EC-02S</b> (3 m)<br> <b>EC-02SB</b> (10 m)<br> <b>EC-02SD</b> (50 m, with reel)<br> <b>EC-02SE</b> (100 m, with reel)<br><small>See p. 48 for external view drawings</small><br><small>※UV-16 does not allow extension with Pre-amplifier VP-26A</small>  |  <b>VM-83</b><br>UV-15<br><br> <b>UV-16</b>                           |
|                           |  Piezoelectric Accelerometer <b>PV-90B</b>   | Ultra-compact Accelerometer Cable <b>VP-51L</b>  |  |  |
| Compact/lightweight       |  Piezoelectric Accelerometer <b>PV-87</b>  | Standard Cable <b>VP-51A</b>   |  Pre-amplifier <b>VP-26A</b><br> Extension Cable <b>EC-02S</b> (3 m)<br> <b>EC-02SB</b> (10 m)<br> <b>EC-02SD</b> (50 m, with reel)<br> <b>EC-02SE</b> (100 m, with reel)<br><small>See p. 48 for external view drawings</small><br><small>※UV-16 does not allow extension with Pre-amplifier VP-26A</small> |  <b>VM-83</b><br>UV-15<br><br> <b>UV-16</b>                          |
|                           |  Piezoelectric Accelerometer <b>PV-90H</b> | Ultra-compact Accelerometer Cable <b>VP-51LB</b>   |  |  |
| High-output               |  Piezoelectric Accelerometer <b>PV-44A</b> | Heat-resistant Cable <b>VP-51B</b>   |  Pre-amplifier <b>VP-26A</b><br> Extension Cable <b>EC-02S</b> (3 m)<br> <b>EC-02SB</b> (10 m)<br> <b>EC-02SD</b> (50 m, with reel)<br> <b>EC-02SE</b> (100 m, with reel)<br><small>See p. 48 for external view drawings</small><br><small>※UV-16 does not allow extension with Pre-amplifier VP-26A</small> |  <b>VM-83</b><br>UV-15<br><br> <b>UV-16</b>                          |
|                           |  Piezoelectric Accelerometer <b>PV-65</b>  | Heat-resistant Cable <b>VP-51B</b>   |  |  |
|                           |  Piezoelectric Accelerometer <b>PV-63</b>  | Heat-resistant Cable <b>VP-51I</b>   |  |  |
|                           |  Piezoelectric Accelerometer <b>PV-93</b>  | Tri-axial Standard Cable <b>VP-51C</b>   |  |  |
| High-temperature          |  Piezoelectric Accelerometer <b>PV-97C</b> | Ultra-compact Accelerometer Cable <b>VP-51L</b> × 3  |  Pre-amplifier <b>VP-26A</b><br> Extension Cable <b>EC-02S</b> (3 m)<br> <b>EC-02SB</b> (10 m)<br> <b>EC-02SD</b> (50 m, with reel)<br> <b>EC-02SE</b> (100 m, with reel)<br><small>See p. 48 for external view drawings</small><br><small>※UV-16 does not allow extension with Pre-amplifier VP-26A</small> |  <b>VM-83</b><br>UV-15<br><br> <b>UV-16</b>                          |
|                           |  Piezoelectric Accelerometer <b>PV-97</b>  | PV-97 Tri-axial Accelerometer Cable <b>VP-51WL</b>   |  |  |
|                           |  Piezoelectric Accelerometer <b>PV-97I</b> | PV-97I Tri-axial Accelerometer Cable <b>VP-51WL</b>  |  |  |
|                           |  Piezoelectric Accelerometer <b>PV-97I</b> | PV-97I Tri-axial Accelerometer Cable <b>VP-51WL</b>  |  |  |
| Triaxial type             |  Piezoelectric Accelerometer <b>PV-97C</b> | Ultra-compact Accelerometer Cable <b>VP-51L</b> × 3  |  Pre-amplifier <b>VP-26A</b><br> Extension Cable <b>EC-02S</b> (3 m)<br> <b>EC-02SB</b> (10 m)<br> <b>EC-02SD</b> (50 m, with reel)<br> <b>EC-02SE</b> (100 m, with reel)<br><small>See p. 48 for external view drawings</small><br><small>※UV-16 does not allow extension with Pre-amplifier VP-26A</small> |  <b>VM-83</b><br>UV-15<br><br> <b>UV-16</b>                          |
|                           |  Piezoelectric Accelerometer <b>PV-97</b>  | PV-97 Tri-axial Accelerometer Cable <b>VP-51WL</b>   |  |  |
| Triaxial type             |  Piezoelectric Accelerometer <b>PV-97I</b> | PV-97I Tri-axial Accelerometer Cable <b>VP-51WL</b>  |  Pre-amplifier <b>VP-26A</b><br> Extension Cable <b>EC-02S</b> (3 m)<br> <b>EC-02SB</b> (10 m)<br> <b>EC-02SD</b> (50 m, with reel)<br> <b>EC-02SE</b> (100 m, with reel)<br><small>See p. 48 for external view drawings</small><br><small>※UV-16 does not allow extension with Pre-amplifier VP-26A</small> |  <b>VM-83</b><br>UV-15<br><br> <b>UV-16</b>                          |
|                           |  Piezoelectric Accelerometer <b>PV-97I</b> | PV-97I Tri-axial Accelerometer Cable <b>VP-51WL</b>  |  |  |
| Servo type                |  Servo Accelerometer <b>LS-10C</b>         | Integrated (1 m)   |  Extension Cable <b>EC-40A</b> (5 m)<br> <b>EC-40B</b> (10 m)<br> <b>EC-40C</b> (30 m, with reel)<br> <b>EC-40D</b> (50 m, with reel)  |  <b>VM-83</b><br>LF-20<br><br> <b>LF-20</b>                          |
|                           |  Servo Accelerometer <b>LS-40C</b>         | Integrated (1 m)   |  |  |
| Servo type                |  Servo Accelerometer <b>LS-10C</b>         | Integrated (1 m)   |  Extension Cable <b>EC-40A</b> (5 m)<br> <b>EC-40B</b> (10 m)<br> <b>EC-40C</b> (30 m, with reel)<br> <b>EC-40D</b> (50 m, with reel)  |  <b>VM-83</b><br>LF-20<br><br> <b>LF-20</b>                          |
|                           |  Servo Accelerometer <b>LS-40C</b>         | Integrated (1 m)   |  |  |

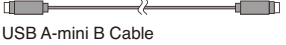

SD-CARD  
Memory card compatible model

# Vibration Meter Connection Examples

| AC Adapter   | Vibration Meter   | Connection Cable   | Peripheral Equipment  |
|--|---|--|---|
| <br><b>AC Adapter NE-21P</b>                        | <br><b>Vibration Level Meter VM-57</b>   |  <b>Computer</b>  | <b>Computer</b><br><br><b>Computer</b><br>*For supported software, see page of respective vibration meter. |
| <br><b>Battery Pack BP-21A*</b><br>*Required CC-43J |   |  <b>Computer</b>  |   |
| <br><b>AC Adapter NC-99A</b>                        | <br><b>Vibration Analyzer VA-12</b>  |  <b>Peripheral device with BNC connector</b>  | <b>External device</b><br><br><b>Rotating light, alarm etc.</b>  |
|  |   |  <b>Peripheral device with BNC connector</b>  |   |
| <br><b>AC Adapter NC-99A</b>                        | <br><b>Vibration Analyzer VA-12</b>  |  <b>Computer</b>  | <b>Peripheral device with BNC connector</b><br><br><b>Level Recorder LR-07</b>                           |
|  |   |  <b>Computer</b>  |   |
| <br><b>AC Adapter NC-98E</b>                       | <br><b>General-Purpose Vibration Meter VM-82A</b>   |  <b>Peripheral device with BNC connector</b>  | <b>Data Recorder DA-21</b><br>   |
|  |   |  <b>Computer</b>   |   |
| <br><b>AC Adapter NC-98E</b>                      | <p><b>Accelerometer sold separately</b><br/>           * For details, see "Accelerometer Selection" on page 32.</p> <br><b>General-Purpose Vibration Meter VM-83</b> |  <b>Computer</b>  | <b>Multi-Channel Signal Analyzer SA-02M/02A4</b><br>   |
|  |   |  <b>Peripheral device with BNC connector</b>  |   |
| <br><b>AC Adapter NC-99A</b>                      | <br><b>Vibration Meter Unit UV-15 Interface Unit UV-22</b>   |  <b>Peripheral device with BNC connector</b><br>* For information on comparator output connection, contact RION distributors. | <b>Portable Multi-function Measuring System RIONOTE</b><br>  |
|  |   |  <b>Peripheral device with BNC connector</b>  |   |
| <br><b>AC Adapter NC-99A</b>                      | <br><b>2-Channel Charge Amplifier UV-16 Battery Unit BP-17</b>   |  <b>Computer</b>  | <b>Outline</b><br><b>Knowledge in a Nutshell</b><br><b>Company Outline</b>  |
|  |   |  <b>Computer</b>  |   |
| <br><b>Battery Unit BP-17</b>                     | <br><b>2-Channel Charge Amplifier UV-16 Battery Unit BP-17</b>   |  <b>Peripheral device with BNC connector</b>  | <b>Outline</b><br><b>Knowledge in a Nutshell</b><br><b>Company Outline</b>  |
|  |   |  <b>Peripheral device with BNC connector</b>  |   |

Acoustics

Vibration

Frequency Analysis

Recording

Related Products

Measuring Instrument Combinations  
External view drawings

Outline

Knowledge in a Nutshell

Company Outline

# Frequency Analysis

Multi-Channel Signal Analyzer SA-02 combines FFT Analysis and 1/1, 1/3, 1/12 Octave Band Analysis Capability

Versatile multi-channel configuration suits many applications

## Multi-Channel Signal Analyzer SA-02M

4ch 8ch 12ch 16ch



- Up to 32 channels supported (using two SA-02M units)
- Allows high frequency analysis in multiple channels
- Direct sensor connection **TEDS compliant**
- Wide range of analysis software available
- Customizing of analysis software also possible
- Easy operation

## Features 4 fixed channels 4-Channel Signal Analyzer SA-02A4

4ch



By linking two SA-02M units, up to 32 channels are supported

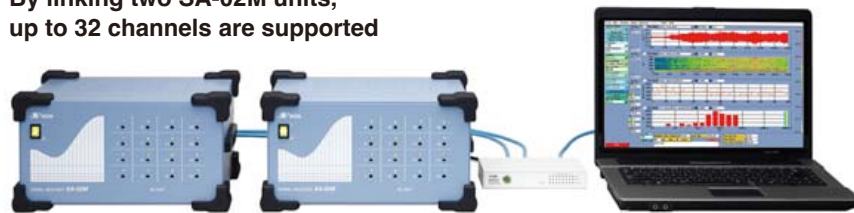

## Standard Software

- Time waveform display / FFT analysis /
- Time waveform recording / Power spectrum map, octave map /
- Transfer function, coherence function /
- Octave band analysis / Recall processing / Overlay display /
- Auto-correlation function / Cross-correlation function
- Amplitude probability density function

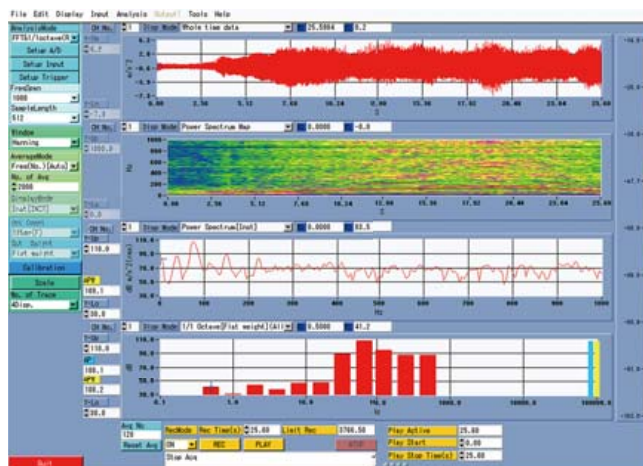

Basic screen layout

## Specifications

|  |  |   |                     |                  |  |  |             |   |
|--|--|---|---------------------|------------------|--|--|-------------|---|
| Standard compliance                            | 1/1, 1/3, 1/12 octave band filters: IEC 61260-1: 2014 class 1 (JIS C 1513-1: 2020 (Filter) JIS C 1514: 2002 class 1), WEEE Directive, RoHS Directive, Chinese RoHS Directive |   |                     |                  |  |  |             |   |
| Frequency range                                | DC to 40 kHz   |   |                     |                  |  |  |             |   |
| FFT analyzer section                           | Analysis frequencies   | 100 Hz / 200 Hz / 500 Hz / 1 kHz / 2 kHz / 5 kHz / 10 kHz / 20 kHz / 40 kHz   |                     |                  |  |  |             |   |
|  | Number of analysis points  | 64 / 128 / 256 / 512 / 1 024 / 2 048 / 4 096 / 8 192 / 16 384 / 32 768  |                     |                  |  |  |             |   |
|  | Time window functions  | Rectangular / Hanning / Flat-top / Exponential / Force Exponential  |                     |                  |  |  |             |   |
|  | Functions  | <table border="1"> <tr> <td>Frequency domain</td> <td colspan="2">Spectrum, cross-spectrum, transfer function, coherence</td> </tr> <tr> <td>Time domain</td> <td colspan="2">Autocorrelation, cross-correlation, amplitude probability density, amplitude probability distribution</td> </tr> </table> |                     | Frequency domain | Spectrum, cross-spectrum, transfer function, coherence |  | Time domain | Autocorrelation, cross-correlation, amplitude probability density, amplitude probability distribution |
| Frequency domain                               | Spectrum, cross-spectrum, transfer function, coherence   |   |                     |                  |  |  |             |   |
| Time domain                                    | Autocorrelation, cross-correlation, amplitude probability density, amplitude probability distribution  |   |                     |                  |  |  |             |   |
| Octave band analyzer section                   | Analysis band range  |   |                     |                  |  |  |             |   |
|  | Number of channels used  | 1 to 4  | 5 to 8              | 9 to 16          |  |  |             |   |
|  | Analysis mode  | 1/1   | 0.5 Hz to 16 kHz    |                  |  |  |             |   |
|  |  | 1/3   | 0.4 Hz to 20 kHz    |                  |  |  |             |   |
| 1/12   | 0.36 Hz to 22 kHz*   | 0.36 Hz to 11 kHz*  | 0.36 Hz to 5.5 kHz* |                  |  |  |             |   |
| *Depending on number of channels used per unit |  |   |                     |                  |  |  |             |   |
| Input/output section                           | AC output connectors / Trigger input connector / Rotary pulse input connector  |   |                     |                  |  |  |             |   |
| Dimensions, Weight                             | SA-02A4  | 58 (H) x 260 (W) x 210 (D) mm (without protruding parts and rubber feet), approx. 2.5 kg  |                     |                  |  |  |             |   |
|  | SA-02M   | 151 (H) x 290 (W) x 249 (D) mm (without protruding parts and rubber feet), approx. 5.4 kg (4 channels installed)  |                     |                  |  |  |             |   |
| Options  |  |   |                     |                  |  |  |             |   |
| 4-Channel Input Unit                           |  | SA-02E4   |                     |                  |  |  |             |   |
| Signal Output Unit                             |  | SA-02S4   |                     |                  |  |  |             |   |

Dedicated Analysis Software

# Airborne Noise/Floor Impact Noise Insulation Measurement Software AS-20PE5

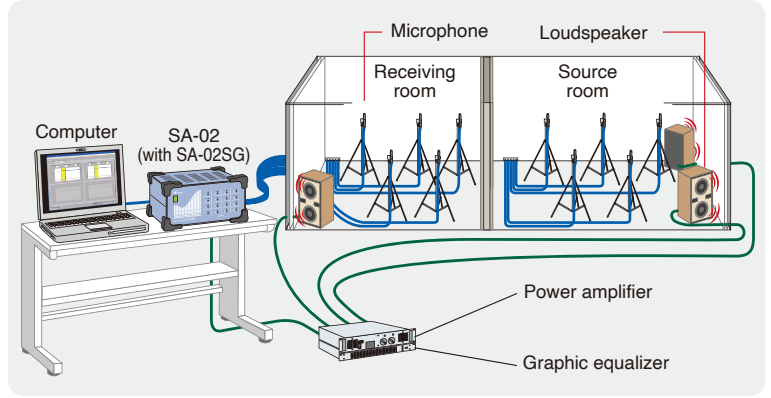

Designed for sound insulation measurement of buildings and building materials based on ISO specifications. Measurement and evaluation for the categories of reverberation time, floor impact sound and attenuation, airborne sound, and sound absorption in a reverberation room are possible.

Applicable standards  
ISO 354 / ISO 140-1 / ISO 140-3 / ISO 140-4 / ISO 140-7 / ISO 140-8 / ISO 717-1 / ISO 717-2

## For impact force measurement of standard heavy impact sources, and octave band measurements of impact force exposure levels Impact Force Measuring Device PF-10

Impact force measurement using an impact ball



Configuration example for measuring impact force characteristics of a bang machine (Height adjustment board optional)

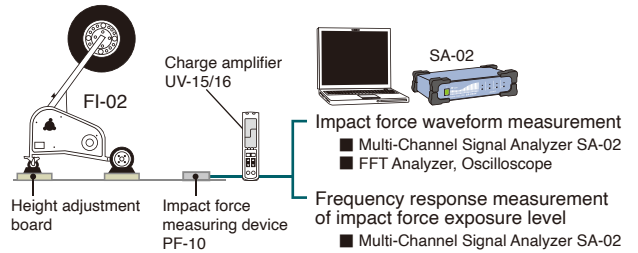

- Impact force waveform measurement
  - Multi-Channel Signal Analyzer SA-02
  - FFT Analyzer, Oscilloscope
- Frequency response measurement of impact force exposure level
  - Multi-Channel Signal Analyzer SA-02

# Loss Factor Measurement Software AS-14PA5

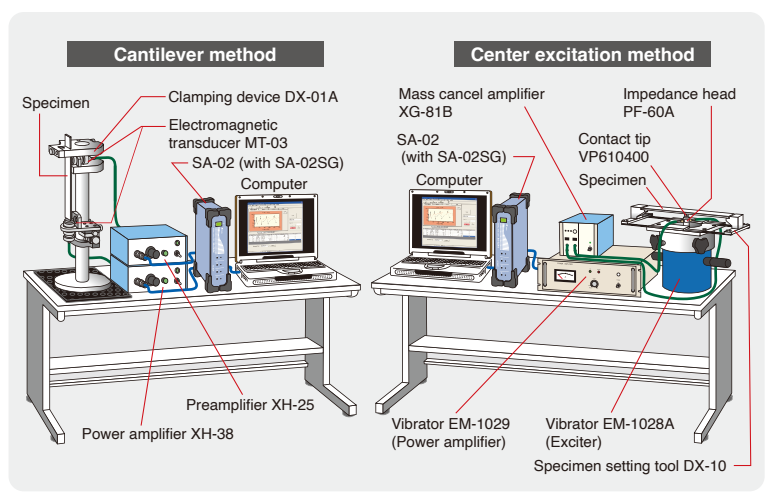
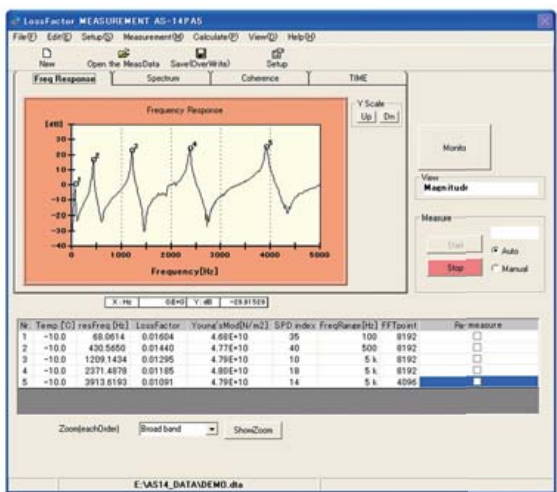

Using the center excitation method or cantilever method, the frequency response of a strip specimen is measured, and the resonance characteristics are used to determine the loss factor and Young's modulus (or shear coefficient) of the specimen according to the half-power bandwidth method.  
Automatic measurement including temperature control of a thermostatic chamber is supported.

Applicable standards  
ISO 10112 / ISO 16940 / ASTM E756-05

\* When performing vibration attenuation testing for non-constraint compound damping, "Monogram display of damping material characteristics" is supported with optional software.

# Frequency Analysis

Dedicated Analysis Software

## Sound Power Level Measurement Software for Hemi-anechoic Room AS-30PA5

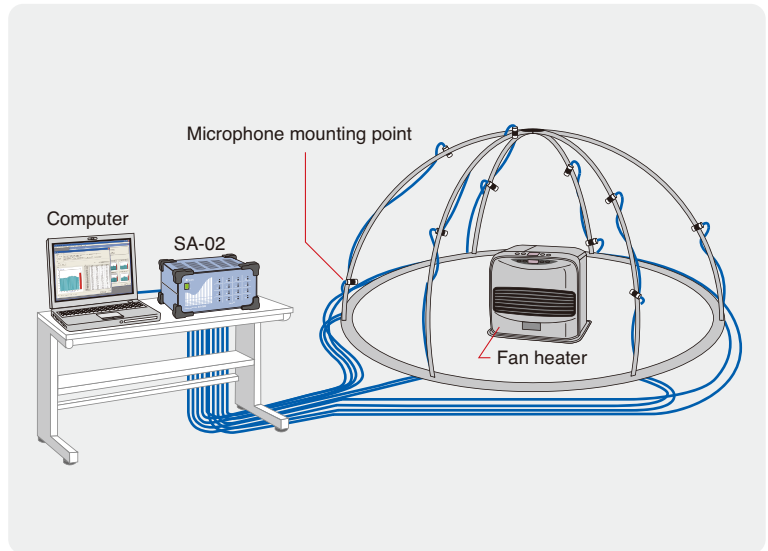
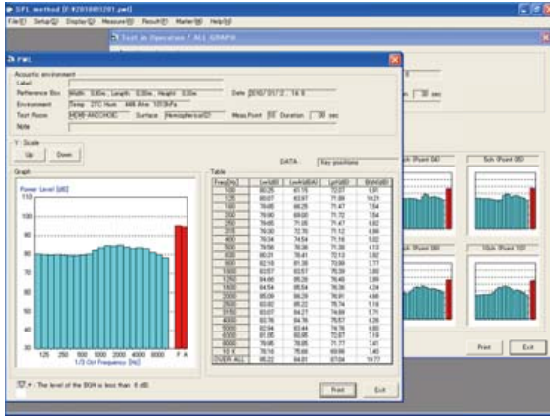

- Allows 1/3 octave band sound power level measurements, according to specifications for sound power level measurements in hemi-anechoic chambers.
- Sound pressure level values are measured in a hemi-anechoic chamber using measurement points arranged on a virtual measurement surface (hemispheric, cuboid). While applying background noise compensation for the sound pressure level at the sound source, the Z-weighted sound power level and A-weighted sound power level values are determined.
- Applicable standards ISO 3745 Acoustics - Determination of sound power levels of noise sources using sound pressure - Precision methods for anechoic and hemi-anechoic rooms  
ISO 3744 Acoustics - Determination of sound power levels and sound energy levels of noise sources using sound pressure - Engineering methods for an essentially free field over a reflecting plane

## Sound Power Level Measurement Software for Reverberation Room AS-31PA5

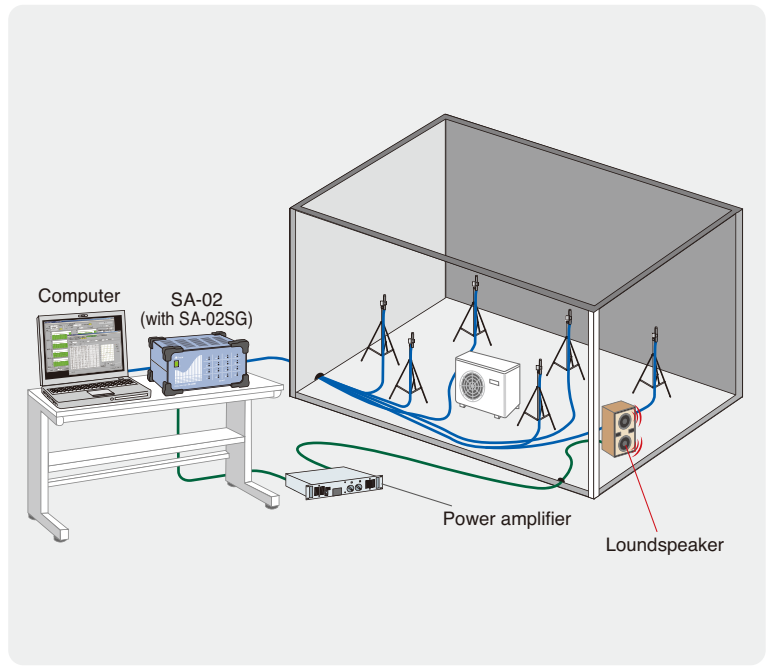
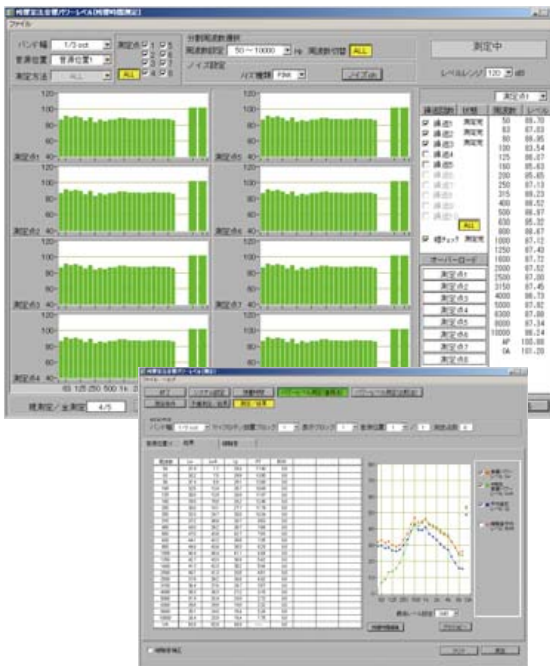

- Supports direct and comparative measurement. Also allows reverberation time measurement.
- Supports multi-channel measurement and microphone rotator use.
- Simultaneous power level measurement for up to 32 channels possible (up to 8 channels for reverberation time measurement).
- Applicable standards ISO 3741: 1999 Acoustics - Determination of sound power levels and sound energy levels of noise sources using sound pressure - Precision methods for reverberation test rooms

## Dedicated Analysis Software

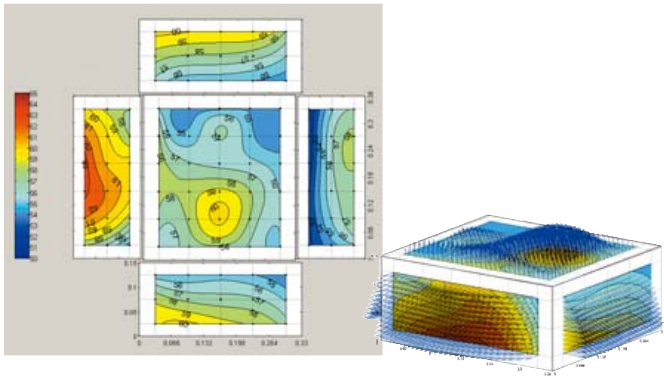
Sound Intensity Measurement Software  
AS-15PA5

- Calculates sound intensity and performs graphics processing.
- Displays frequency spectrum, band level, and intensity spectrum information as spectrum line diagram, contour diagram, or mesh diagram, and shows sound power levels.

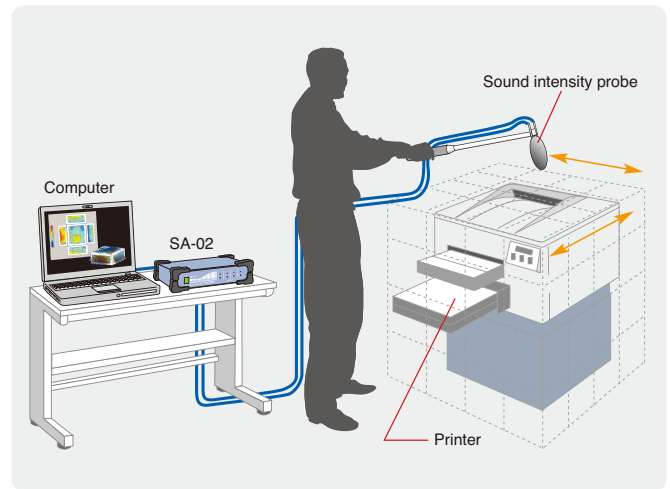
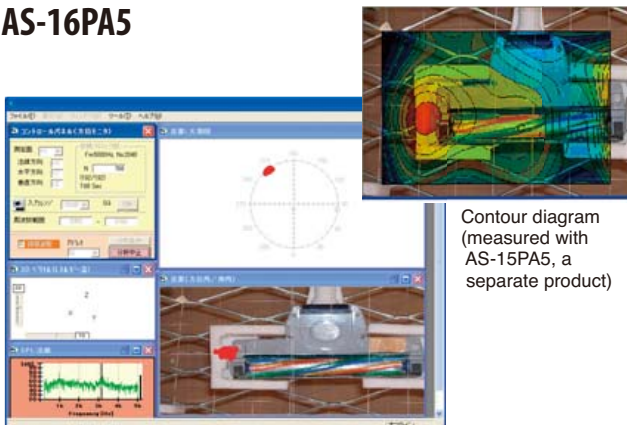
Sound Source Location Software  
AS-16PA5

Contour diagram (measured with AS-15PA5, a separate product)

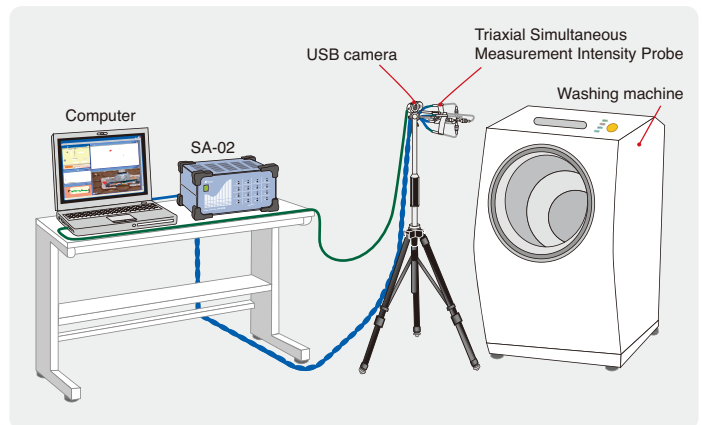

- Determines sound incident direction using a 3-axis sound intensity probe, and displays it on screen along with a camera image.
- Overlays presumed sound source location with captured image and allows selecting the frequency (range) to analyze.
- Also supports moving sound source measurement on video (option).

## Intensity Probe (CCLD (Constant Current Linear Drive) principle)

## Sound intensity measurement sensor

Sound Intensity Probe  
SI-31I

- For sound intensity measurements, the sound pressure and the sound particle velocity must be determined. The sound particle velocity is approximated from the pressure gradient between two microphones positioned in close proximity.
- This dedicated probe determines the sound pressure gradient with high accuracy, using a spacer arrangement with two condenser microphones.

## Specifications

| Construction principle |                             | Face to face, with integrated preamplifier        |
|------------------------|-----------------------------|---|
| Shape                  | Effective acoustic distance | 12 mm: 200 Hz to 5 kHz<br>50 mm: 50 Hz to 1.2 kHz |

## Measure sound intensity in three dimensions

Triaxial Simultaneous Measurement  
Intensity Probe  
SI-33I

- Allows simultaneous measurement of sound intensity in all directions of a three-dimensional orthogonal coordinate system
- Dedicated microphones capable of capturing an intensity vector as a three-dimensional spatial vector
- Three sets of 1/2 inch electret microphone pairs UC-53I with matching phase frequency response characteristics and two preamplifiers are combined with the Multi-Channel Analyzer SA-02

## Specifications

| Construction principle |                             | Face to face, with integrated preamplifier        |
|------------------------|-----------------------------|---|
| Shape                  | Effective acoustic distance | 31 mm: 100 Hz to 2 kHz<br>50 mm: 50 Hz to 1.2 kHz |

# Frequency Analysis

## Dedicated Analysis Software

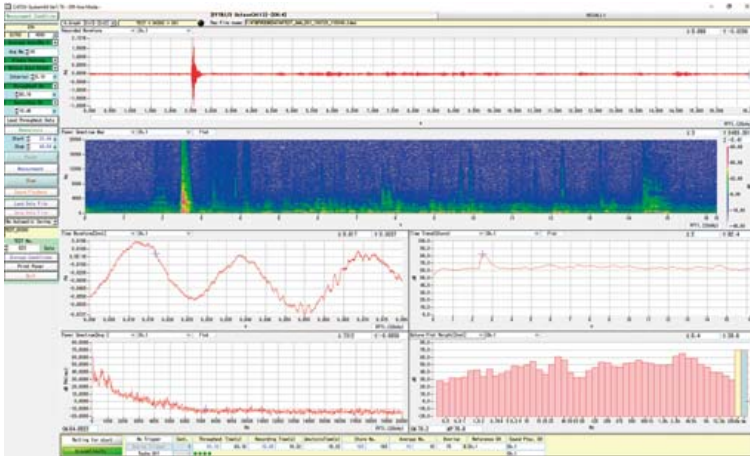

Basic screen

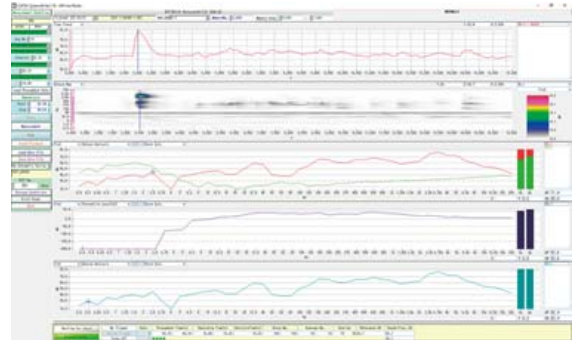

Recall screen

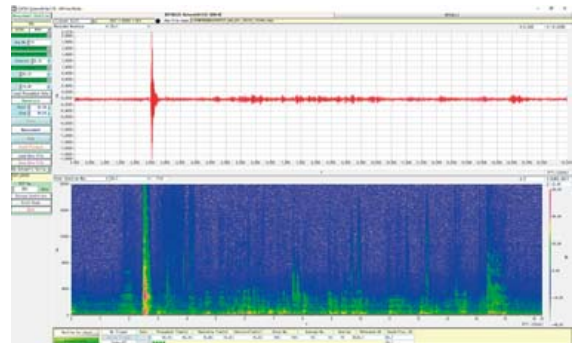

Spectrum map screen

## Sound and Vibration Measurement System CAT-SA02-Pro

- Supports simultaneous FFT analysis, octave band analysis, and recall processing while recording time waveform data
- Allows combined viewing of downsampled FFT analysis results
- Supports simultaneous analysis for two sets of frequencies and number of sampling points
- Supports long-term time wave recording
- Comments and event notes can be attached to analysis results
- Combination with a USB camera or high-speed camera allows measurement while simultaneously recording video (option)
- Supports order ratio tracking analysis and sound quality evaluation (option)

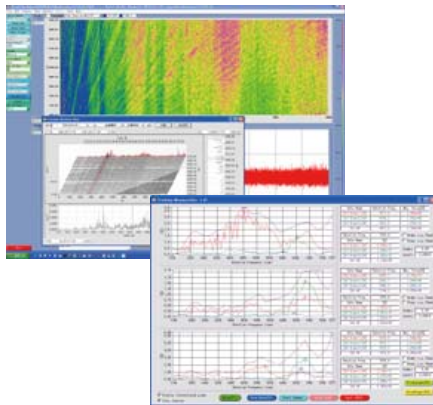

## Tracking Analysis Software CAT-SA02-Order

(This software is a product of Catec Inc.)

- Rotation data and sound/vibration data are recorded simultaneously to analyze the rotation order ratio.
- Available display formats include three-dimensional mapping, Campbell diagram, rpm-level display and more.

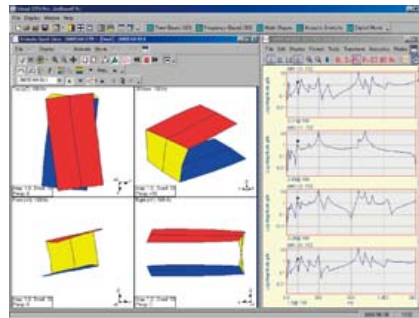

## Mode Analysis Software ME' Scope VES

(This software is a product of Vibrant Technology Inc.)

- Allows direct linking of SA-02 and mode analysis software
- Measurement points and direction for each channel can be displayed on screen using arrows, making it easy to check the next measurement point.
- Analysis using animated display can be generated in a few steps.

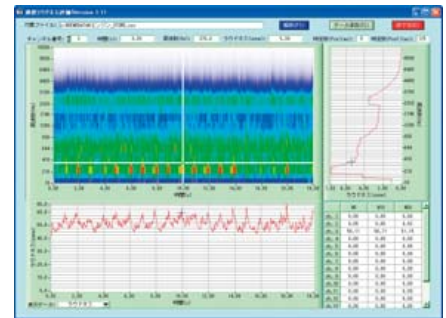

## Sound Quality Evaluation Software CAT-SA02-SQ

(This software is a product of Catec Inc.)

- WAVE data collected with the SA-02 and similar data can be imported into a measurement data file and used to calculate psychoacoustic evaluation quantities.
- Calculates loudness (steady-state and transient\*), sharpness, roughness, intensity fluctuation, and tonality evaluation parameters.  
\*Calculation of transient loudness available as an option.

Dedicated Analysis Software

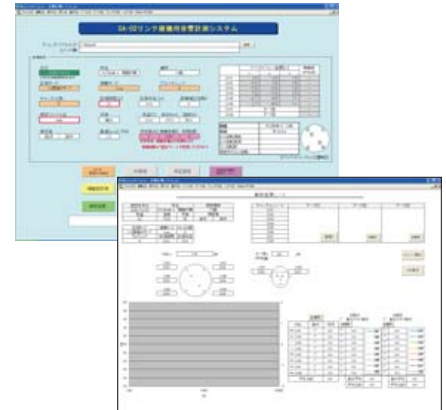
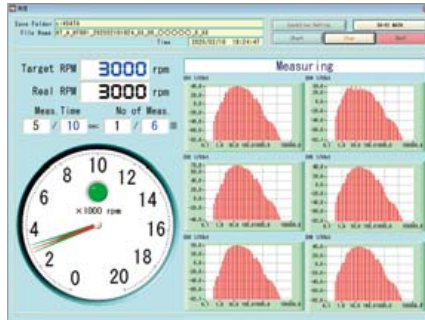
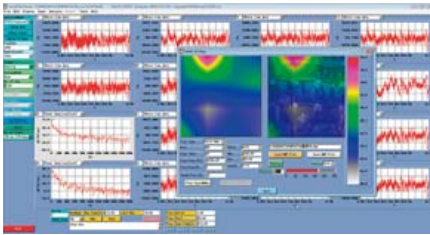

### Array Type Visualization Software CAT-SA02-AR

(This software is a product of Catec Inc.)

- Sound pressure level fluctuations and changes are made visible using a 32-microphone array.
- Visualization can be performed separately by frequency or overall. Microphone frequency analysis results can be displayed for each mode.
- Power spectrum and 3-D spectrum map can be observed for each array element, based on sound pressure level at the measurement position. Overlay with image data from a digital camera or similar is also possible.

### Hand-arm Vibration Measurement Software CAT-SA02-HT

(This software is a product of Catec Inc.)

- Frequency-weighted acceleration rms values are measured for the X, Y, Z axes simultaneously. From these values ( $a_{hwX}$ ,  $a_{hwY}$ ,  $a_{hwZ}$ ), the software determines the triaxial combined value  $a_{tr}$ .
- Applicable standards  
ISO 8041 / ISO 5349-2

### Sound Power Level Measurement Software for Construction Machinery CAT-SA02-CPWL

(This software is a product of Catec Inc.)

- Using an Excel macro, the sound power level of construction machinery can be measured.
- Applicable standards  
ISO 6395 / ISO 6393

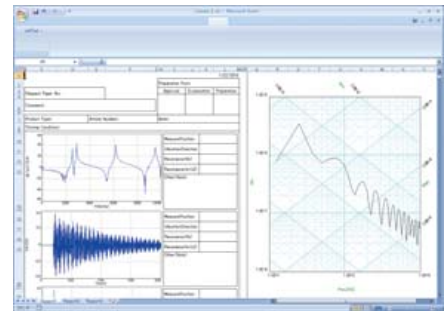
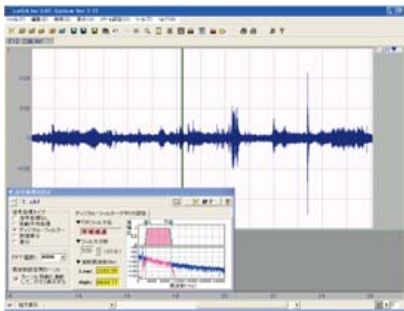
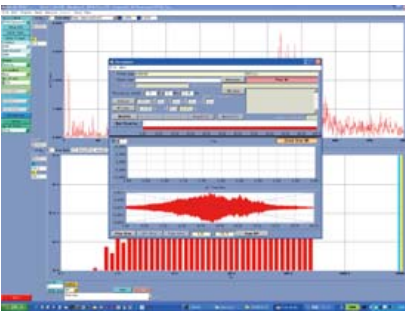

### Throughput Disk CAT-SA02-TH

(This software is a product of Catec Inc.)

- Long-term time waveform recording

### Waveform Data Manipulation Software CAT-SA32

(This software is a product of Catec Inc.)

- Versatile data manipulation
- FFT processing
- Arithmetic processing
- Overlay display
- Storing manipulated data
- Data import function

### Report Creation Support Tool CAT-Report

(This software is a product of Catec Inc.)

- Excel add-on
- Ease of operation
- XY graph
- Cell linking function

# Frequency Analysis

## Dedicated Analysis Software

Unusual noise and abnormal vibrations generated on a production or inspection line can be detected from the FFT analysis results of the Multi-Channel Signal Analyzer SA-02 to implement pass / fail evaluation.

## Sound and Vibration Evaluation System

- **Self-learning type evaluation system**  
Utilizes Mahalanobis distance (MTA method)
- **Threshold evaluation system**  
Pass / fail evaluation using a threshold area enclosed by upper and lower frequency level limits
- **Comparative evaluation using reference level**  
Calculates and compares the reference level from the average value and standard deviation
- **Real-time sound quality evaluation system for noise detection**  
Uses sound quality evaluation parameters such as transient loudness and sharpness
- **Bearing vibration evaluation system**  
Automatically determines bearing fault locations from bearing parameters and rotation speed

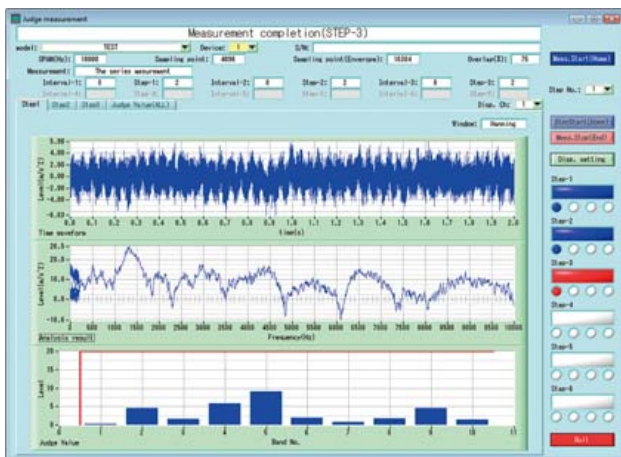
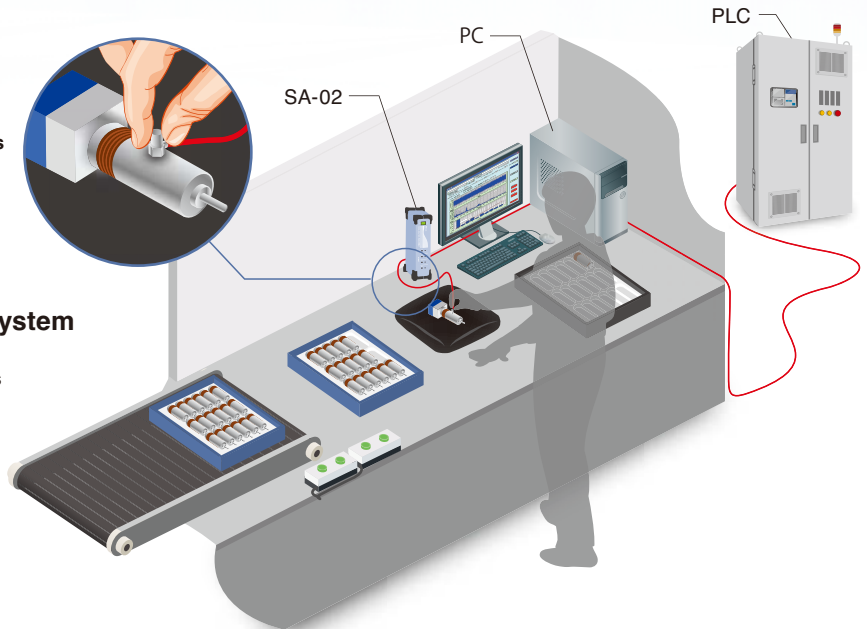

### Self-learning Evaluation System CAT-CMP-MTA

(This software is a product of Catec Inc.)

Using the Mahalanobis distance (MTA method) for statistical analysis, the system can be trained to recognize OK (Pass) products and mark products not in the OK group as NG (Fail). The evaluation threshold is set by the distance from each frequency range set.

- Simultaneous evaluation in multiple channels supported
- Evaluation thresholds can be set separately for each testing stage
- Evaluation thresholds can be set separately for each machine
- By defining a frequency range, evaluation thresholds can be set for each frequency range
- Automatic measurement using DIO communication or PLC communication supported

**Application examples:**  
transmission, combustion engine

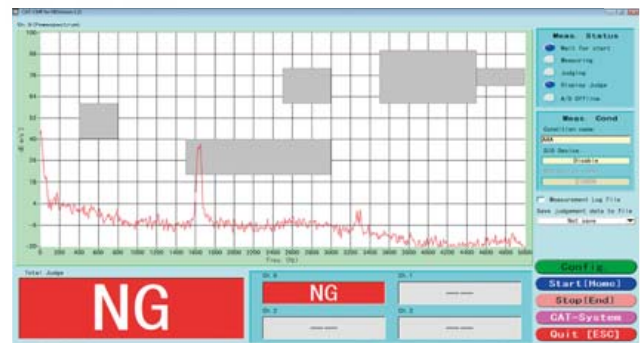

### Threshold Evaluation System CAT-SA02-CMP01

(This software is a product of Catec Inc.)

A square threshold area is formed by specifying the upper and lower frequency and upper and lower level where abnormality occurs. The program then determines whether the respective measured peak level falls within this area.

- Up to five evaluation threshold area can be set
- AND/OR linking of threshold area is possible
- Settings can also be made for all-pass level
- Peak level or partial overall level can be selected

**Application examples:**  
electric motor, combustion engine, compressor





## Reference Level Comparison Method Evaluation System CAT-CMP-REF

(This software is a product of Catec Inc.)

OK (Pass) products are measured several times, and the average value and standard deviation are calculated from the data for each frequency. The calculation results are used to set multiple frequency ranges. If level standard deviation is within range (such as  $3\sigma$  etc.), the product is marked as OK, otherwise as NG (Fail). In the above sample screen, yellow is the OK range and red indicates the measured data.

- Simultaneous evaluation in multiple channels supported
- Evaluation thresholds can be set separately for each testing stage
- Evaluation thresholds can be set separately for each machine
- By defining a frequency range, evaluation thresholds can be set for each frequency range
- Automatic measurement using DIO communication or PLC communication supported

**Application examples:**  
transmission, combustion engine

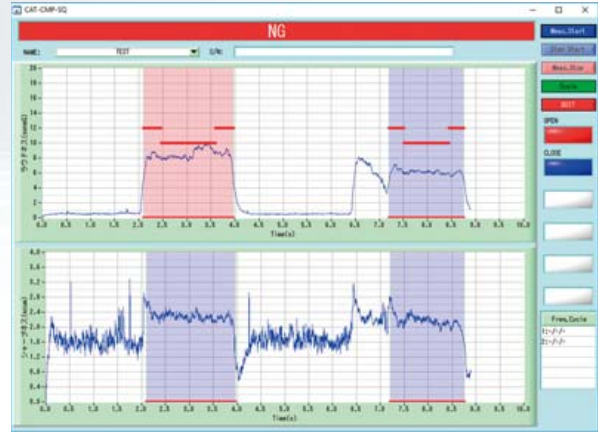

## Real-time Sound Quality Evaluation System for Noise Detection CAT-CMP-SQ

(This software is a product of Catec Inc.)

Applying an analytic method that closely simulates human hearing (transient loudness [DIN 45631 standard], sharpness is used to determine abnormal noise from a product. This allows identification also of sounds that could not be evaluated by sound pressure level measurements alone.

- Simultaneous evaluation in 4 channels supported
- Evaluation can be performed by transient loudness (according to DIN 45631 standard) and transient sharpness
- Evaluation thresholds can be set separately for each testing stage
- Evaluation thresholds can be set separately for each machine
- Automatic measurement using DIO communication or PLC communication supported

**Application examples:**  
electric motor, automotive parts

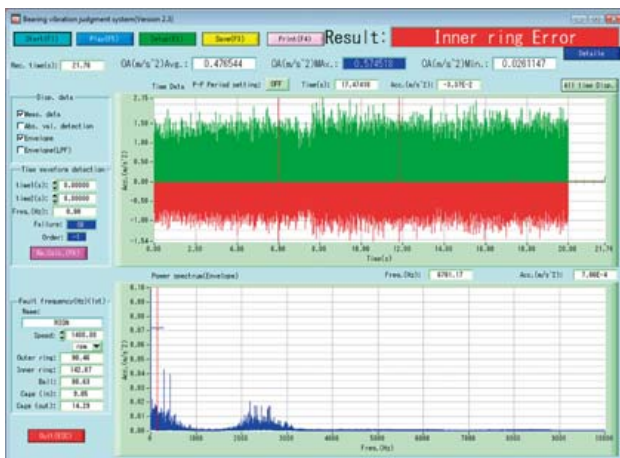

## Bearing Vibration Evaluation System CAT-CMP-BR

(This software is a product of Catec Inc.)

Allows automatic evaluation of bearing faults based on bearing parameters and rotation speed, by setting a frequency for bearing damage. When an abnormality is detected, the location can also be identified (inner ring, outer ring, rolling element, cage).

- Evaluation by input of bearing parameters and rotation speed
- Evaluation by envelope function supported
- Indication of fault location (inner ring, outer ring, rolling element, cage) supported
- Evaluation thresholds can be set separately for each machine
- Automatic measurement using DIO communication or PLC communication supported

**Application examples:**  
bearing

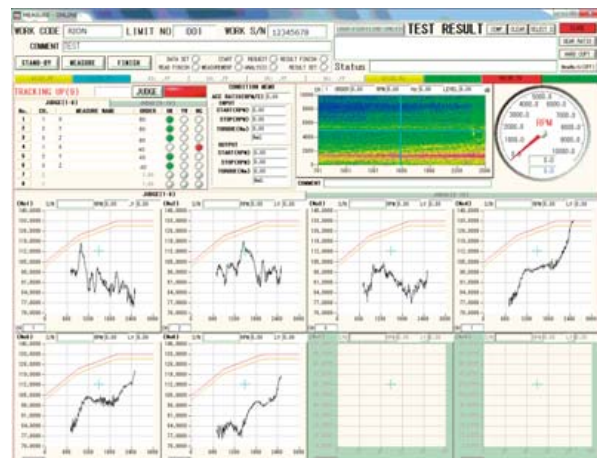

## FFT & Order Tracking Evaluation System CAT-CMP-ORD

(This software is a product of Catec Inc.)

Performs FFT analysis of a measurement object in steady rotation, and allows threshold evaluation of frequency on the horizontal axis and level on the vertical axis. For a measurement object with fluctuating rotation, order tracking evaluation is performed by measuring rotation speed and calculating the order values. For each specified order, threshold evaluation of frequency on the horizontal axis and level on the vertical axis is possible. Evaluation threshold values can be set separately for each type of measurement object.

**Application examples:**  
transmission, combustion engine, electric motor, compressor, and other rotating machinery

# Frequency Analysis

**Compact design, easy and intuitive operation**  
**Wireless connections**  
**Use it anytime anywhere!**



## Portable Multi-function Measuring System **RIONOTE**

RIONOTE consist of a Main Control Unit SA-A1 which can be configured to up to 16 channels and allowing you to perform measurements anywhere wireless. The Main Control Unit is easy and intuitive to operate, with the dedicated program of your choice. All on a large color touch screen.



### Specifications (Main control unit and amplifier)

|  |   |
|--|---|
| Number of channels                       | 4(2), BNC connectors, CCLD, AC/DC   |
| CCLD                                     | 2 mA 24 V (4 mA Factory option)   |
| Frequency Range                          | DC to 20 kHz or 0.25 Hz to 20 kHz   |
| Dynamic range                            | 100 dB or better (0 dB range, fs = 51.2 kHz, 400 line FFT noise level)                  |
| A/D converter                            | 24 bit, delta-sigma type, simultaneous sampling   |
| Tacho pulse input, General purpose input |   |
| Number of channels                       | 1, BNC connector  |
| Tacho pulse                              |   |
| Input voltage range                      | 0 - 12 V, open collector supported, internal pull-up<br>3.3 V (pull-up resistance 1 kΩ) |
| H-L threshold level                      | 2.5 V   |
| Measurement rotation speed range         | 5 000 pulse/s   |
| General purpose                          |   |
| A/D converter                            | 10 bit successive approximation type  |
| Sampling frequency                       | Approx. 10 Hz   |

|                      |   |
|----------------------|---|
| Display              | 10.1 inch TFT color LCD   |
| Touch panel          | Multi-touch (2 points), projected capacitive type   |
| Input/output section |   |
| USB                  | USB A x 1, mini B x 1   |
| Earphone jack        | Yes, Stereo mini jack, φ3.5   |
| SD card slot         | Yes (SDHC support, max. 32 GB)  |
| SD card              | SDHC support, max. 32 GB  |
| Power supply         | Li-Ion battery, AC adapter  |
| Dimensions, Weight   | 188 (H) x 275 (W) x 30 (D) mm<br>SA-A1: 1 200 g (incl. 280 g battery, SA-A1B4 mounted)          |
| Supplied accessories | Rechargeable Li-Ion battery, AC adapter, SA-A1 file converter, AS-70 Viewer, Instruction manual |

## Main Control Unit SA-A1 and Amplifier SA-A1B4/B2

Supports direct connection of microphones and piezoelectric accelerometers.



Sensor amplifier slides into the underside of main unit

## Wireless Dock SA-A1WD (and Amplifier)

Separate type wireless dock and amplifier (2 channel or 4 channel configuration)



RIONOTE also enables the use of a wireless dock to avoid the cost and hassle of cables. A plurality of wireless docks and wireless sensor amplifiers can be used simultaneously, up to 16 channels, to store the measured data in the Main Control Unit as well as in the memory of wireless dock

\*Selling of Wireless dock (SA-A1WD) differs from each country. Please contact us for further questions.

**Analysis Program**

**Program for  
FFT Analysis  
SX-A1FT**

FFT analysis can be performed.



|                           |  |
|---------------------------|--|
| Arithmetic functions      | Time domain waveform for 1 frame, Power spectrum, Cross spectrum, Transfer function, Coherence |
| Window functions          | Rectangular, Hanning, Flat-top, Exponential, Force   |
| Analysis frequencies      | 20 kHz, 10 kHz, 5 kHz, 2 kHz, 1 kHz, 500 Hz, 200 Hz, 100 Hz                                    |
| Number of analysis points | 256, 512, 1 024, 2 048, 4 096, 8 192, 16 384   |

**Program for  
1/3 Octave Analysis  
SX-A1RT**

Octave band and 1/3 octave band analysis can be performed.



|  |   |
|--|---|
| Standard compliance                                | IEC 61260-1:2014 class1, ANSI/ASA S1.11-2004/Part1 class1   |
| Band filter center frequencies and number of bands |   |
| Octave bands                                       | 0.5 to 16 000 Hz, 16 bands<br>Max. 4 channels   |
| 1/3 octave bands                                   | 0.4 to 20 000 Hz, 48 bands<br>Max. 3 channels   |
| Instantaneous value data (every 100 ms)            | Time weighted level $L_p$ ,<br>Time averaged level $L_{eq}$ ,<br>Time weighted maximum level $L_{max}$  |
| Processing value data                              | Time averaged level $L_{eq}$ ,<br>Sound exposure level $L_E$ ,<br>Time weighted maximum level $L_{max}$ ,<br>Time percentile level $L_N$ (5, 10, 50, 90, 95, 33.3), max. 5 values |

**Program for  
Waveform Recording  
SX-A1WR (Installed in SA-A1 main unit)**

It is possible to display and record the time waveform. The waveform can be analyzed on SX-A1FT. Recorded WAVE files can be analyzed with the Waveform Processing Software AS-70



|                            |  |
|----------------------------|--|
| Frequency range            | 20 kHz, 10 kHz, 5 kHz, 1 kHz, 500 Hz, 100 Hz                   |
| Quantization               | 16 bit/24 bit  |
| Voice memo marker function | Yes  |
| Monitor output (playback)  | Allows listening to recorded data (20 kHz, 10 kHz, 5 kHz only) |
| Recorded data              | WAVE format  |

● Analysing is available also on the computer.

**Vibration Analysis Program  
SX-A1VA**

This program adds vibration measurement functions.

- All essential vibration measurement functions are provided, enabling equipment diagnosis and trend management for industrial machinery.
- The program also supports detailed diagnosis including FFT analysis and envelope processing.



|  |   |
|--|---|
| Vibration frequency range (using PV-57I) |   |
| Acceleration                             | 0.02 to 141.4 m/s <sup>2</sup> (rms)                        |
| Velocity                                 | 0.2 to 141.4 mm/s (rms, at 159.15 Hz)                       |
| Displacement                             | 0.02 to 40.0 mm (EQ peak-peak, at 15.915 Hz)                |
| FFT analysis mode                        | Power spectrum Time waveform of 1 frame                     |
| Frequency range                          | 100 Hz, 200 Hz, 500 Hz, 1 kHz, 2 kHz, 5 kHz, 10 kHz, 20 kHz |
| Number of analysis lines                 | 200, 400, 800, 1 600, 3200                                  |

**Judgment Program  
(Pass/Fail Evaluation)  
SX-A1CMP**

This program is suitable for pass/fail evaluation of noise, vibrations and other phenomena in production or inspection lines.

- It allows the definition of evaluation windows for FFT analysis results to determine pass/fail.



**Order Tracking Program  
CAT-SAA1-ORDTRK  
(This software is a product of Catec Inc.)**

Noise or vibration evaluation to assess causes of resonance phenomena related to revolution speed changes

- Automatic analysis based on recorded revolution data and noise/vibration waveform data



# Recording

Capable of recording acoustic / vibration waveforms and various voltage signals in the field  
Recorded data are saved in WAVE format on SD cards and can be imported into a computer for waveform analysis and other processing tasks

## 4 channel Data Recorder DA-21 CE



- Incorporates support for CCLD (Constant Current Line Drive) 2 mA
- DC to 20 kHz frequency range
- Inter-unit synchronization (max.8 channels)
- Light weight: only 450 g (excluding batteries)
- 180 minutes recording time (2 channels, 20 kHz x 2.4)\*  
\*Using 2 GB memory card

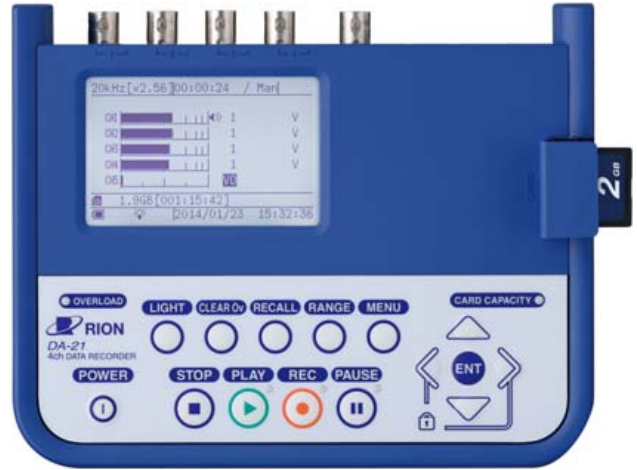

### Specifications

|                   |                                    |  |
|-------------------|------------------------------------|--|
| Input section     | Signal input                       | 4 channels (BNC), 1 channel (BNC rotation speed)   |
|                   | CCLD (Constant Current Line Drive) | 2 mA, 24 V   |
|                   | Frequency response                 | DC coupling<br>DC to 1 Hz: ±1.0 dB, 1 Hz to 12.5 kHz: ±0.5 dB,<br>12.5 kHz to 20 kHz: ±1.0 dB<br>AC coupling<br>1 Hz: ±1.0 dB, 1 Hz to 12.5 kHz: ±0.5 dB,<br>12.5 kHz to 20 kHz: ±1.0 dB |
| Output section    | Playback output connectors         | 4 channels, φ2.5 monaural jacks  |
| Recording section | Media                              | SD card [up to 32 GB (FAT16/32 )]<br>(Use RION supplied cards for assured operation)   |
| Trigger section   | Trigger mode                       | Free, single, repeat (split files in repeat mode)  |

|                      |       |   |
|----------------------|-------|---|
| Power supply section | Power | Four IEC R6 (size AA) batteries, AC adapter (NC-98E, option), Cigarette plug adapter CC-82 (option)                 |
| Dimensions, Weight   |       | Approx. 140 (H) x 175 (W) x 45 (D) mm, approx. 450 g (not including batteries), approx. 770 g (including batteries) |

● Re-analysing is available on the computer.

### Options

|                              |                           |
|------------------------------|---------------------------|
| Memory card (2 GB SD card*)  | MC-20SD2                  |
| Memory card (32 GB SD card*) | MC-32SP3                  |
| Inter-unit sync cable        | CC-43                     |
| Battery Pack                 | BP-21A                    |
| AC adapter                   | NC-98E                    |
| BNC-BNC Coaxial Cable        | EC-90 series (2 m and up) |
| BNC-BNC Cable                | NC-39A                    |

\*Use RION supplied cards for assured operation

● Maximum recording times with 32 GB SD card (approximate)  
Sampling frequency: frequency range x 2.56 (2.4 also supported)

| Number of channels |               | Frequency range (Hz) |             |            |            |           |        |
|--------------------|---------------|----------------------|-------------|------------|------------|-----------|--------|
|                    |               | 100                  | 500         | 1 000      | 5 000      | 10 000    | 20 000 |
| 1                  | 1 7066 h 40 m | 3413 h 20 m          | 1706 h 40 m | 341 h 20 m | 170 h 40 m | 85 h 20 m |        |
| 2                  | 8 533 h 20 m  | 1 706 h 40 m         | 853 h 20 m  | 170 h 40 m | 85 h 20 m  | 42 h 40 m |        |
| 3                  | 5 688 h 32 m  | 1 137 h 36 m         | 568 h 48 m  | 113 h 36 m | 56 h 48 m  | 28 h 24 m |        |
| 4                  | 4 266 h 40 m  | 853 h 20 m           | 426 h 40 m  | 85 h 20 m  | 42 h 40 m  | 21 h 20 m |        |

\*Actual times may differ slightly depending on number of files \*Maximum recording time for one file is approx. 1000 hours \*Use RION supplied cards for assured operation

● Maximum recording times with 2 GB SD card (approximate)  
Sampling frequency: frequency range x 2.56 (2.4 also supported)

| Number of channels |             | Frequency range (Hz) |            |           |           |          |        |
|--------------------|-------------|----------------------|------------|-----------|-----------|----------|--------|
|                    |             | 100                  | 500        | 1 000     | 5 000     | 10 000   | 20 000 |
| 1                  | 1066 h 40 m | 213 h 20 m           | 106 h 40 m | 21 h 20 m | 10 h 40 m | 5 h 20 m |        |
| 2                  | 533 h 20 m  | 106 h 40 m           | 53 h 20 m  | 10 h 40 m | 5 h 20 m  | 2 h 40 m |        |
| 3                  | 355 h 32 m  | 71 h 06 m            | 35 h 33 m  | 7 h 06 m  | 3 h 33 m  | 1 h 46 m |        |
| 4                  | 266 h 40 m  | 53 h 20 m            | 26 h 40 m  | 5 h 20 m  | 2 h 40 m  | 1 h 20 m |        |

## Multi-Channel Signal Analyzer SA-02M/02A4

DA-21 recorded data file can be analyzed by this unit with the software Throughput Disk also.



## Provides various display and analysis functions for WAVE file Viewer Software AS-70 Viewer (supplied with DA-21)

Supported models : RIONOTE, NX-43WR, NX-42WR, NX-28WR, SA-78WR, DA-21/20/40, VA-12, VX-55WR/57WR, SX-A1VA

- WAVE files can be displayed as Time waveform and Time-weighted level waveform, replayed and exported (WAVE or CSV format).

### Specifications

|          |                     |   |
|----------|---------------------|---|
| Waveform | Display functions   | Amplitude waveform, level waveform      |
|          | Weighting functions | 10 ms, F (Fast), 630 ms, S (Slow), 10 s |

\*Supported operating system: Microsoft Windows, 10 Pro 64 bit, 11 Pro 64 bit

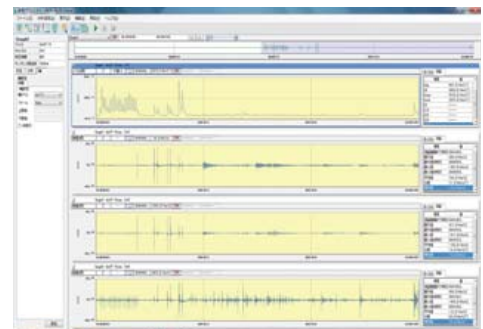

4-channel display screen

## Waveform Analysis Software AS-70

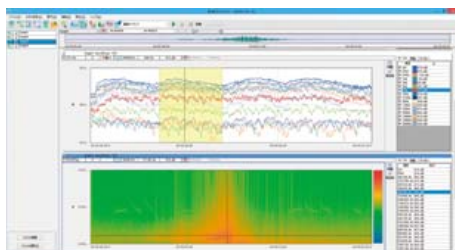

Waveform analysis screen example

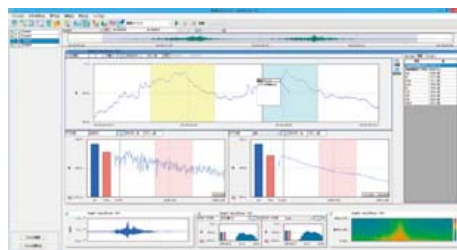

Waveform analysis screen example

Supported models : RIONOTE, NX-43WR, NX-42WR, NX-28WR, SA-78WR DA-21/20/40, VA-12, VX-55WR/57WR, SX-A1VA

- Allows importing waveform data from Rion sound level meters, vibration meters, data recorders and similar to a computer as WAVE files, to perform 1/1 and 1/3 octave band analysis and FFT analysis.
- File export and playback are also supported.

### Specifications

|                                     |                           |   |
|-------------------------------------|---------------------------|---|
| Waveform analysis                   | Processing                | Maximum value, minimum value, average value, effective value, distribution, differentiation and integration, HPF, LPF |
| Frequency weighting characteristics |                           | Z, A, C, G, C to A, vertical vibration characteristics, horizontal vibration characteristics                          |
| FFT analysis                        | Number of analysis points | 32 to 65 536  |
|                                     | Data view                 | Power spectrum, power spectrum density, spectrogram   |
| Time weighting characteristics      |                           | 10 ms, F (Fast), 630 ms, S (Slow), 10 s   |
| Octave band analysis                | Applicable standards      | IEC 61260-1: 2014, JIS C 1513-1: 2020 class1 (Filter)   |
|                                     | Frequency range           | 1/1 octave band 0.5 Hz to 16 kHz (16 bands)<br>1/3 octave band 0.4 Hz to 20 kHz (48 bands)                            |

### Recommended operation environment

|         |  |
|---------|--|
| CPU     | Intel Core i5 2 GHz or faster                          |
| RAM     | 2 GB or more, 4 GB recommended                         |
| HDD     | 20 GB or more (free space), 100 GB or more recommended |
| DISPLAY | XGA (1024 x 768 pixels) resolution or higher           |
| OS      | Microsoft Windows, 10 Pro 64 bit, 11 Pro 64 bit        |

## Waveform Analysis Software CAT-WAVE (This software is a product of Catec Inc.)

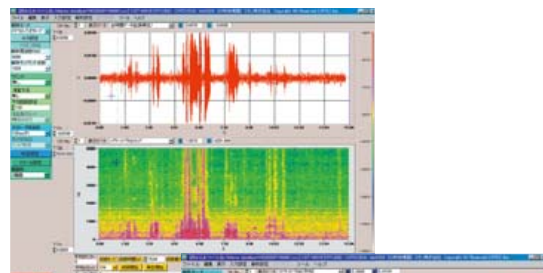

Spectrum map screen



Overlay screen (Power spectrum map)

Applicable to : NX-42WR, NX-28WR, SA-78WR, DA-21/20/40, VA-12

- Signals recorded in WAVE file can be analyzed, and the result of analysis can be stored.
- FFT analysis or Octave analysis can be selected.

### Specifications

|                      |                     |   |
|----------------------|---------------------|---|
| Waveform             | Display             | Scaled time axis, Differential and integral calculus available  |
| FFT analysis         | Sampling points     | 64 to 32 768 points   |
|                      | Display function    | Power spectrum, Cross spectrum, Transfer function, Coherence, Power spectrum map, Octave map, Differential and calculus for spectrum area |
| Octave band analysis | Applicable standard | IEC 61260-1: 2014, JIS C 1513-1: 2020 class1 (Filter), JIS C 1514: 2002 class1  |
|                      | Frequency range     | Octave band 0.5 Hz to 8 kHz (15 bands),<br>1/3 octave band 0.4 Hz to 10 kHz (45 bands),<br>1/12 octave band 0.36 Hz to 11 kHz (180 bands) |

### Operating environment requirements

|         |  |
|---------|--|
| CPU     | Intel Core i5/i7 1.4 GHz or more (Core2 Duo 2 GHz or more) |
| RAM     | 2 GB or more   |
| HDD     | 60 GB (free space) or more                                 |
| DISPLAY | SXGA (1280 x 1024) or more                                 |
| OS      | Microsoft Windows, 8.1 Pro 64 bit, 10 Pro 64 bit           |

## Level recorder featuring simple operation Level Recorder

LR-07

Type certification number: JR-9



- Besides sound and vibration level recording, this automatic balancing level recorder is suitable for performance characteristics testing of acoustic devices and transducers, DC voltage linear recording, and more
- Paper speed control function increases feed rate while level exceeds a preset threshold, for easier reading of recorded results

### Specifications

|                             |   |
|-----------------------------|---|
| Applicable standard         | JIS C 1512 : 1996   |
| Level range                 | 10 dB, 25 dB, 50 dB, Linear   |
| Measurement frequency range | 1 Hz to 100 000 Hz  |
| Paper feed rate             | 0.01, 0.03, 0.1, 0.3, 1, 3, 10, 30 mm/s   |
| Power                       | Six IEC R20 (size D) batteries, AC adapter (NC-99A, option), external DC input (12 V) |
| Dimensions, Weight          | Approx. 122 (H) x 250 (W) x 325 (D) mm, approx. 3.6 kg (including batteries)          |
| Options                     |   |
| Recording Paper             | RP-01D (6 rolls)  |
| Level Recorder Pen (Red)    | LB-25B (set of 6)   |

# Related Products

Allows easy measurement of fluid viscosity

## Viscometer

VT-06 



Designed for quality control applications in the manufacturing process of industrial products such as petrochemicals, paint, and adhesives, as well as foodstuffs. Measurement is performed by simply immersing a rotor in the fluid. The resistance to rotor movement caused by the viscosity (torque) is measured to obtain direct readings.

- Compact and lightweight make the unit easily portable and allow operation with one hand
- Can be powered by alkaline batteries, nickel-hydride rechargeable batteries, or AC adapter
- Direct indication of viscosity in decipascal-seconds (SI units)
- Dedicated stand for measurement available as option

### Specifications

|                       |  |
|-----------------------|--|
| Measurement range     | No. 3 rotor: 0.3 to 13 dPa.s (with No. 3 cup)<br>No. 1 rotor: 3 to 150 dPa.s (with JIS 300 mL beaker*)<br>No. 2 rotor: 100 to 4000 dPa.s (with JIS 300 mL beaker*)   |
| Sample fluid capacity | No. 1 and No. 2 rotor (with JIS 300 mL beaker*) approx. 300 mL<br>No. 3 rotor (with No. 3 cup) approx. 170 mL<br>Clearance between rotor end and cup bottom: about 15 mm   |
| Measurement accuracy  | ±10 % ±1 digit of indicated value, reproducibility ±5 %  |
| Rotor speed           | 62.5 rpm   |
| Power supply          | IEC LR6 (size AA) alkaline batteries,<br>Ni-MH rechargeable batteries, AC adapter VA-05JA  |
| Dimensions, Weight    | 175 (H) × 77 (W) × 40 (D) mm (without protruding parts),<br>Approx. 260 g (without batteries)  |
| Supplied accessories  | No. 1 rotor (dia. 24 × 53 × 166 mm) SUS304 1<br>No. 2 rotor (dia. 15 × 1 × 113 mm) SUS304 1<br>No. 3 rotor (dia. 45 × 47 × 160 mm) SUS304 1<br>No. 3 Cup (dia. 52.6 × 75 mm) SUS304 1<br>Extension rod (900 mm · 300 × 3) SUS304 1<br>IEC LR6 (size AA) alkaline batteries 4 |

**Note** ● The Viscometer cannot measure accurately with anything other than supplied cups or the JIS 300 mL beaker.

\* 1 JIS R 3503 : 1994, φ78×103 (H)

|            |         |
|------------|---------|
| Options    |         |
| Stand      | VA-04   |
| AC adapter | VA-05JA |



## Applications

Thanks to its great usability, portability, and reliability, RION's viscometer VT-06 has been gaining good reputations from various industries, all over the world.



### Food Industry

Thickness is an essential component for foods such as soup, sauce, paste, and oils.

To control these characteristics will directly contribute to maintain the quality of the final product. As food viscosity shall be strongly affected by its temperature, understanding coherence of viscosity and temperature for each product is also important. Examples: Tomato paste, Condensed soup, Curry, Fresh juice Smoothie, Olive oil, Chocolate, Creme



### Paint

Today, it seems impossible to find something that is not painted. Not just coloring, paint has important tasks of adding protecting function. As painting has been playing important part of manufacturing, quality of the paint is strictly controlled. If you use inadequate paint product, it may have some problem; it is not easy to apply, it will not sufficient performance.



### Chemicals

With its wide measurement range, the VT-06 can be applicable to chemical industries. It can measure grease, oil, adhesive, resin, detergent, and so on. VT-06 is very easy to carry and you can instantly start the measurement, so you can do the measurement wherever viscosity matters. Examples: Engine oil, Lubrication grease, Adhesive, Resin, Detergent, Gum, Cement

**Perform precise measurements of volume of engine combustion chambers in seconds with no fluid needed**

## Acoustical Volumeter (For combustion chamber volume measurement)



- The volume of a combustion chamber, regardless of its size and shape, can be measured by simply placing the sensor of the RION Acoustical Volumeter on the combustion chamber cavity of the cylinder head.
- For assembled engines, a special adapter can be used to connect the sensor of the volumemeter to the spark plug hole.
- The Acoustical Volumeter can measure the precise volume of a combustion chamber in about two seconds. This instrument is perfect for the process of engine manufacturing or maintenance.
- Capacity measurement : repeat precision  $\pm 0.05 \text{ cm}^3$   
(When a volume of  $50 \text{ cm}^3$  is measured under standard environmental conditions ( $20 \text{ }^\circ\text{C}$ ,  $50 \%$ ))



\* For cylinder head



\* For complete engine

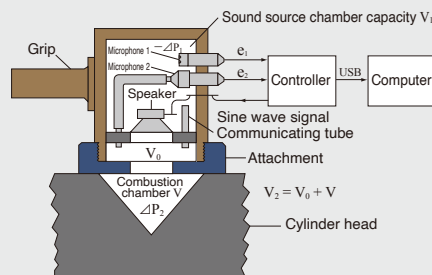

### Cross-sectional drawing

- Prior to the measurement, use a few types of reference standards for calibration and obtain the required parameters.
- Measurement is done by attaching the sound source chamber to the object.

## Acoustical Volumeter (For volume of solid object)



- Even the volume of objects with complex shape, such as a golf ball, can be measured accurately in about two seconds.
- Volume measurement : repeat precision  $\pm 0.1 \text{ cm}^3$   
(When a volume of  $100 \text{ cm}^3$  is measured under standard environmental conditions ( $20 \text{ }^\circ\text{C}$ ,  $50 \%$ ))

[Theory]

Unlike the conventional method using Archimedes Principle (where the target object is immersed in a fluid (water or oil) and the displaced liquid's volume is measured), the volume meter system, using acoustics, allows volume and density measurement of the target object in a dry state.

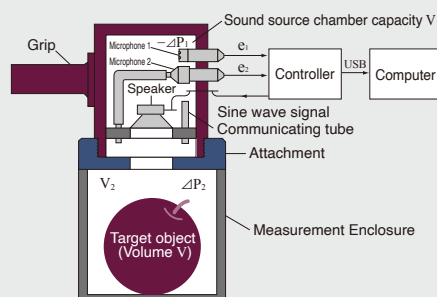

### Cross-sectional drawing

- Prior to the measurement, use a few types of reference standards for calibration.
- Put the object into the measurement enclosure for measurement.
- To measure the density, measure the mass of the object in advance.

# External view drawings of measurement microphone and accelerometer cables

Units: mm

## Sound Level Meter Cables

### EC-04/04A/04B

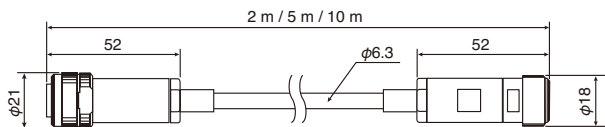

### EC-04C/04D/04E (with reel)

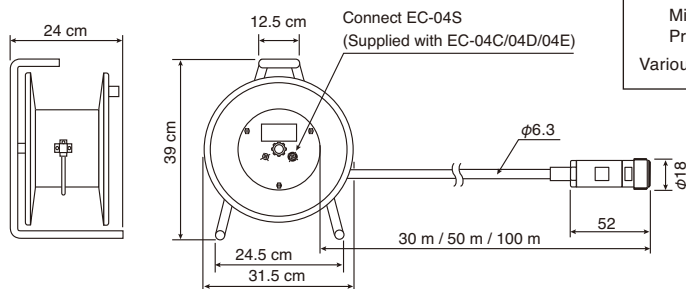

| Type                          | Model             | Length           |
|-------------------------------|-------------------|------------------|
| 7P Microphone Extension Cable | <b>EC-04</b>      | 2 m              |
|                               | <b>EC-04A</b>     | 5 m              |
|                               | <b>EC-04B</b>     | 10 m             |
|                               | <b>EC-04C</b>     | 30 m (with reel) |
|                               | <b>EC-04D</b>     | 50 m (with reel) |
| <b>EC-04E</b>                 | 100 m (with reel) |                  |

● EC03001

| Sensor  | Main Unit   |
|---|---|
| Microphone Pre-amplifier<br>Various <a href="#">See p. 20</a> | Measuring Amplifier <b>NA-42</b><br>Sound Level Meter Unit <b>UN-14</b> |

Can also be used as extension cable for these sound level meters

**NA-28, NA-42, NL-43/53/63**

### EC-04S (for connection of sound level meter to reel)

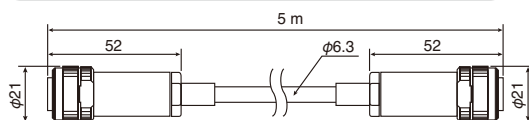

## BNC-BNC Coaxial Cable

### EC-90A/90B

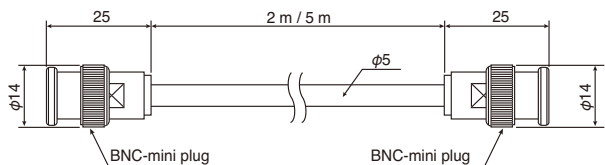

| Type                  | Model         | Length |
|-----------------------|---------------|--------|
| BNC-BNC Coaxial Cable | <b>EC-90A</b> | 2 m    |
|                       | <b>EC-90B</b> | 5 m    |

| Sensor  | Main Unit  |
|---|--|
| Microphone Pre-amplifier<br>Various <a href="#">See p. 20</a> | Sound Level Meter Unit <b>UN-14</b><br>Multi-Channel Signal Analyzer <b>SA-02</b><br>Data Recorder <b>DA-21</b><br>Portable Multi-function Measuring System <b>RIONOTE</b> |

## Accelerometer Cables

### VP-51A

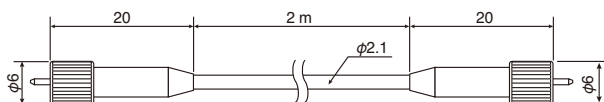

| Type           | Model         | Length |
|----------------|---------------|--------|
| Standard Cable | <b>VP-51A</b> | 2 m~   |

| Sensor  | Main Unit  |
|---|--|
| Piezoelectric Accelerometers<br>Various <a href="#">See p. 32</a> | General-Purpose Vibration Meter <b>VM-83</b><br>Vibration Meter Unit <b>UV-15</b><br>2-Channel Charge Amplifier <b>UV-16</b> |

## Vibration Level Meter Cables

### EC-54S/54SA/54SB

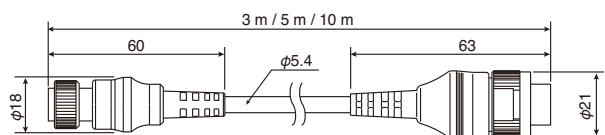

| Type   | Model          | Length            |
|--|----------------|-------------------|
| Extension Cable                                  | <b>EC-54S</b>  | 3 m               |
|  | <b>EC-54SA</b> | 5 m               |
|  | <b>EC-54SB</b> | 10 m              |
| Vibration Level Meter/<br>Vibration Meter Cables | <b>EC-02SD</b> | 50 m (with reel)  |
|  | <b>EC-02SE</b> | 100 m (with reel) |

| Sensor  | Main Unit                          |
|---|------------------------------------|
| Triaxial Accelerometer (Supplied with main unit)<br><a href="#">See p. 25</a> | Vibration Level Meter <b>VM-57</b> |

### EC-02SD/02SE (with reel)

\* It is also possible to connect the EC-04 series

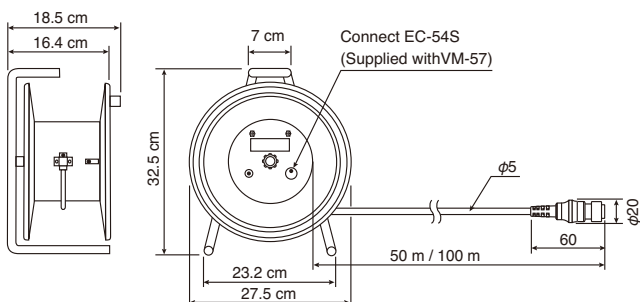

## Microphone Holders

### ● EC03001

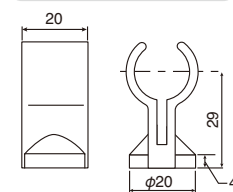

### ● UA-90

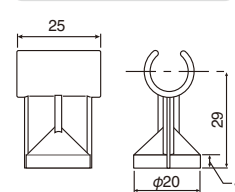



# Measuring Instrument Combinations

## 1

### Acoustic Measurement

Before starting an acoustic or vibration measurement, three factors must be considered:

- What kind of sound/vibration is to be measured?
- For what purpose?
- Which kind of processing is required (recording, analysis etc.)?

Depending on these factors, the measurement method, type of measuring instrument, and choice of peripheral equipment will differ. Selecting the right combination of products is essential for achieving accurate and reliable results. The following pages are intended to help with the selection of equipment, by describing some representative configurations and showing connection examples.

#### INDEX

|    |   |    |
|----|---|----|
| 1  | Acoustic Measurement  | 49 |
| 2  | Calibration of Sound Level Meters and Vibration Meters                        | 49 |
| 3  | Sound Level Meters and Vibration Level Meters in the Field                    | 50 |
| 4  | Measurement of ground vibrations  | 50 |
| 5  | Sound Level Monitoring  | 50 |
| 6  | Noise Measurement at Working Places   | 51 |
| 7  | Low-Frequency Sound Measurement   | 51 |
| 8  | Quality Management Based on Sound and Vibrations                              | 51 |
| 9  | Sound-Proof Chambers, Anechoic Chambers, Echo Chambers                        | 52 |
| 10 | Measurement of Sound Insulation and other Performance Parameters of Buildings | 52 |
| 11 | Acoustic Intensity · Sound source location                                    | 52 |
| 12 | Sound Power Level   | 53 |
| 13 | Sound quality evaluation  | 53 |
| 14 | Pure tone evaluation  | 53 |
| 15 | Measurement of Mechanical Vibrations  | 54 |
| 16 | Vibration Monitoring  | 54 |
| 17 | Industrial Machinery Equipment Diagnosis                                      | 54 |
| 18 | Whole-Body Vibration Measurement  | 55 |
| 19 | Hand-arm Vibration Measurement  | 55 |
| 20 | Mode Analysis   | 55 |
| 21 | Tracking Analysis System  | 56 |
| 22 | Measurement of Low-Frequency Microvibrations                                  | 56 |
| 23 | Vibration measurement with sound level meter                                  | 56 |

In acoustic measurements requiring high accuracy, the basic instrument combination consists of a condenser microphone and preamplifier. To this, other equipment, such as a frequency analyzer and data recorder, is added as needed.

The type of condenser microphone will be determined by factors such as the target sound pressure level, frequency range, and sound field conditions. The general-application Sound Level Measuring Amplifier NA-42 is suitable as an amplifier for these microphones. Frequency analyzers come in two types: constant-ratio type real-time analyzers and constant-amplitude type FFT analyzers. In the former category, RION offers the Precision Sound Level Meter NA-28 with the 1/3 octave band real-time analyzer function. In the FFT category, there is the Portable Multi-function Measuring System RIONOTE. The Multi-Channel Signal Analyzer SA-02 and Portable Multi-function Measuring System RIONOTE provides both 1/1, 1/3, 1/12<sup>\*\*</sup> octave band real-time analysis\* and FFT analysis\* capability.

※ SA-02 only  
\* RIONOTE is optional

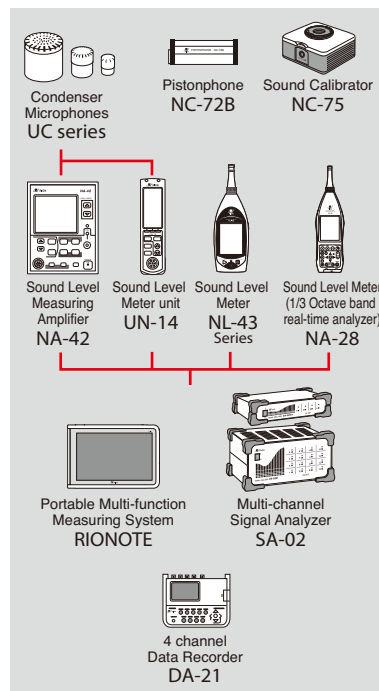

## 2

### Calibration of Sound Level Meters and Vibration Meters

#### ● Calibration of sound level meters and similar devices

For overall checking of sound level meters and acoustic measurement systems, RION offers the Sound Calibrator NC-75 (1 kHz, sound pressure level 94 dB), as well as the Pistonphone NC-72B (250 Hz, 114 dB).

#### ● Calibration of vibration meters and similar devices

In order to make it possible for users to easily calibrate vibration meters and vibration accelerometers, RION offers the Calibration Exciter VE-10 (159.2 Hz, acceleration 10 m/s<sup>2</sup>, velocity 10 mm/s, displacement 10 μm).

#### Calibration of sound level meters and similar devices

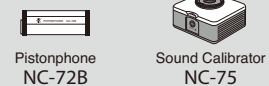

#### Calibration of vibration meters and similar devices



# Measuring Instrument Combinations

## 3

### Sound Level Meters and Vibration Level Meters in the Field

The basic model lineup for JIS and IEC standard compliant sound level meters is the NL series. For on-site measurements of vibration levels, the Japan Measurement Law and JIS compliant Vibration Level Meters VM-57 are suitable. The NL-43 series (SD cards) and the VM-57 series (SD cards) use memory cards to allow long-term recording of vibration level data and calculated data. Data stored on memory cards can be utilized by the dedicated software applications AS-60 and AS-60VM for data graph display, editing, further processing, and creating daily and weekly reports. The NL-43 series supports use of the Octave Band and 1/3 Octave Band Real Time Analysis Program NX-43RT and the FFT Analysis Program NX-43FT. The Data Management Software AS-60 allows playback of real sound files. Analysis data saved with the NX-43RT can be displayed, edited, and processed using the Data Management Software (With Octave and 1/3 Octave Data Management Software) AS-60RT. The VM-57 allows use of the 1/3 Octave Real-Time Analysis program VX-57RT for frequency analysis. For recording of sound level and vibration level data, RION level recorder LR-07 is useful. Sound pressure waveform and vibration acceleration waveform information can be recorded using a 4 channel data recorder DA-21, allowing for later analysis with waveform processing software.

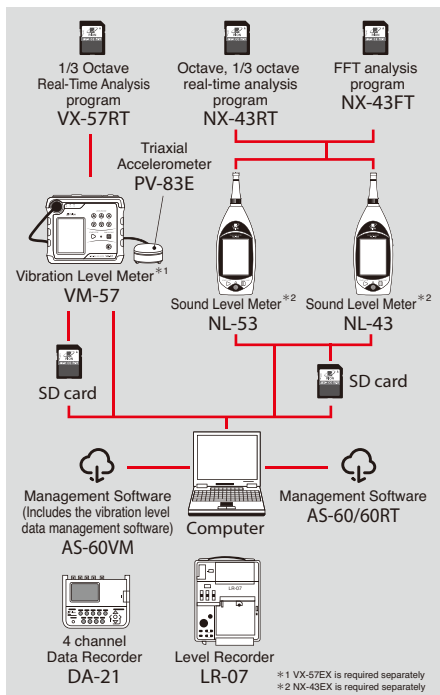

## 4

### Measurement of groundborne vibrations

The Tri-axial Groundborne Vibration Meter VM-56 can be used for measuring groundborne vibrations, for example in accordance with the stipulations for "Building damage" and "Human annoyance in buildings" of DIN 4150-2/-3 and ISO 8041, or for mining vibration measurements etc. By using the Waveform Recording Program VX-56WR or the Waveform Analysis Software for Groundborne Vibration AS-70GV, detailed frequency analysis is also possible. Because the sensor and the unit are waterproof (sensor IPX7, main unit IP54), long-term measurements present no problem. Similar to the data of short-term measurements, data are saved on the SD card in CSV format, which enables editing on a computer without the need for proprietary software. To facilitate report creation, an Excel macro is supplied free of charge. Utilizing online connection via a communications circuit, long-term monitoring from a remote site is possible. The communication function also makes it easy to configure a live-to-web system, and the high quality for which RION products are famous contributes significantly to data security in a long-term setup. High reliability minimizes the risk of missing data.

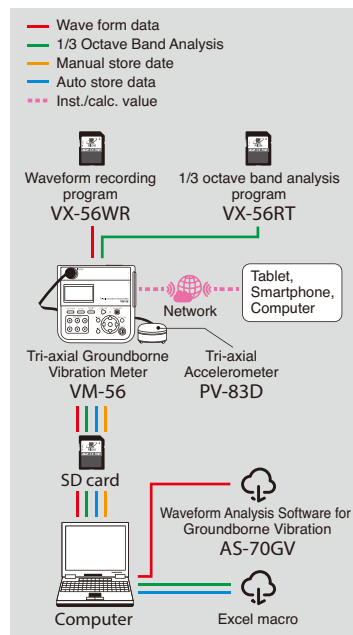

## 5

### Sound Level Monitoring

Plant Noise Monitoring System Noise level monitoring is widely used as part of noise control measures to improve the living environment in the vicinity of factories. For short-term measurement, a system that combines the Sound Level Meter NL-43 series with the Level Recorder LR-07 and an all-weather windscreens can be used (Figure 1). We recommend the NL-43 series of sound level meters (controlled from a web browser) for factory noise monitoring. Simply connect the sound level meter to a network to remotely monitor the measurement status of the sound level meter from a web browser. Web browser functions include viewing of the measurement data, remote operation of the sound level meter (measurement settings, start and stop of measurement, time synchronization, etc.), real-time audio playback, file download, and a marker function. This range of functions makes it possible to perform noise monitoring of equipment and machinery at factories. (Figure 2)

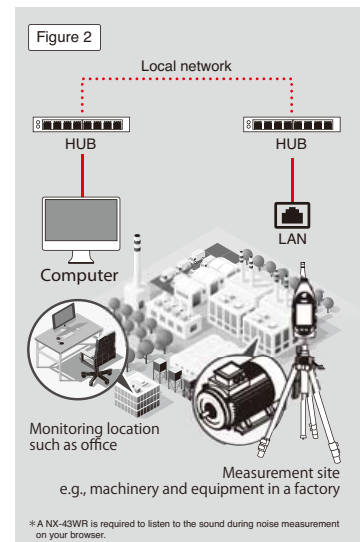
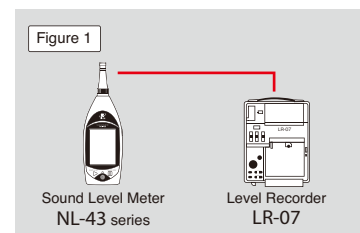

# 6

## Noise Measurement at Working Places

The measurement of sound exposure levels is an important prerequisite for protecting personnel working in an environment with high sound level from hearing damage. Regulations to control generation of noise at work places have come into force in many countries. For instance, The Noise Prevention Guideline issued by the Japanese Labor Ministry (currently the Health, Labor and Welfare Ministry) in 1992 provides the framework for measurement and evaluation of equivalent continuous sound pressure levels. The Sound Level Meter NL-43 series is suitable for such measurements. When the NL-43 series is used, the results can be stored on a SD card and later exported to a spreadsheet application for easy processing. The Octave Band and 1/3 Octave Band Real Time Analysis Program NX-43RT can also be used to analyze the frequency ranges that are critical for noise countermeasures. The Sound Level Meter NA-28 with the 1/3 octave band real-time analyzer function is also a highly useful tool. Analysis data saved with the NX-43RT and NA-28 can be displayed, edited, and processed using the Data Management Software (With Octave and 1/3 Octave Data Management Software) AS-60RT.

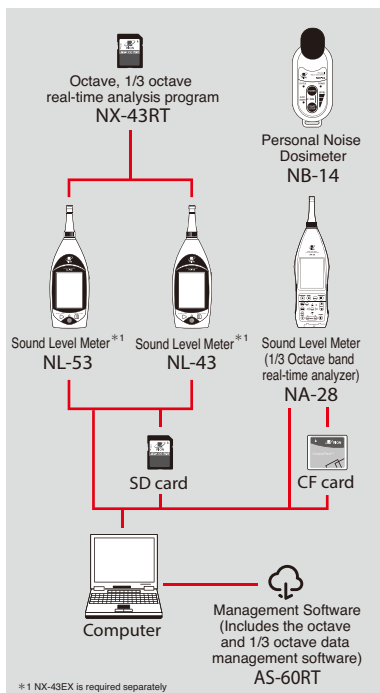

# 7

## Low-Frequency Sound Measurement

So-called infrasound in the range below the human hearing threshold, from 1 Hz to about 20 Hz, can have a physiological impact on humans if sound pressure levels are very high. It can also cause other unwanted effects such as window rattling and develop into an environmental problem. To measure sound in this range, the Sound Level Meter NL-63 + NX-63RT which provides G characteristics as defined by ISO 7196 and 1/3 octave band analysis can be used. By connecting the Level Recorder LR-07 or a 4 channel Data Recorder DA-21 the level changes and sound pressure signal condition can be recorded.

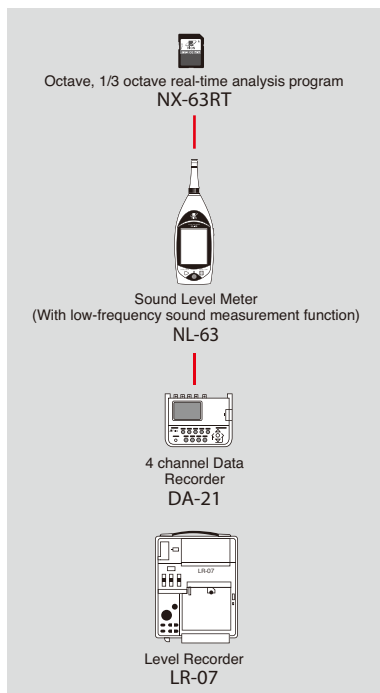

# 8

## Quality Management Based on Sound and Vibrations

Measuring the noise level and vibrations produced by machinery and other equipment can often provide valuable data for quality control. Depending on the characteristics of the measurement target, UC series microphones or PV series accelerometers are used as sensors connected to equipment such as the Sound Level Meter Unit UN-14, Vibration Meter VM-83 or Charge Amplifier UV-15/16. When only the sound or vibration Level is to be measured, the NL-43 series, NA-42, or VM-83 with comparator function are suitable. If detection of unusual sound or other frequency analysis processing is required, the Multi-Channel Signal Analyzer SA-02, Portable Multi-function Measuring System RIONOTE, or High-Precision Sound Level Meter NA-28 (with 1/3 octave band analysis capability) are useful. For pass/fail evaluation of products in a manufacturing process, the Multi-Channel Signal Analyzer SA-02 series and evaluation software of the CAT-SA02-CMP01 series, or the Portable Multi-function Measuring System RIONOTE and dedicated evaluation software (under development) are suitable.

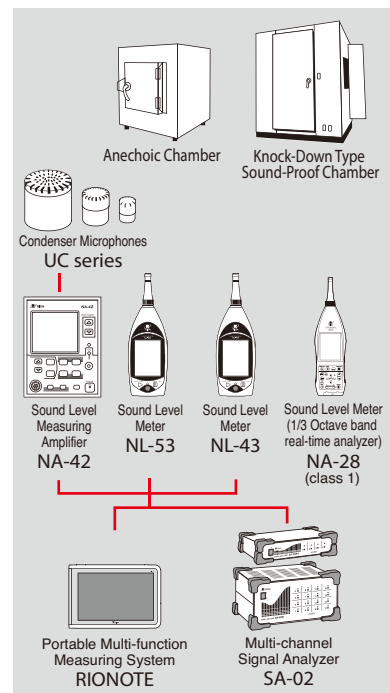

# Measuring Instrument Combinations

## 9

### Sound-Proof Chambers, Anechoic Chambers, Echo Chambers

When performing acoustic measurements, special conditions must often be established, such as low-noise environment, semi-free sound field, free sound field, or diffuse sound field.

- **Low-noise environment**  
Using a sound-proof chamber or box, when the sound level emitted by equipment is low, ambient noise can influence a measurement. To prevent this, place the measurement target in a sound-proof chamber or box. In some cases, using an anechoic chamber or box where the influence of reflections is minimized can also be useful. For acoustic power level measurements according to the sound pressure method or for measuring the sound insulation characteristics of building materials, a semi-free sound field, free sound field, or diffuse sound field must be realized, according to standard stipulations. This can be achieved by using suitable RION products.
- **Hemi-free sound field**  
Using a semi-anechoic chamber. Except for the floor, all surfaces of such chambers are specially treated for sound absorption to minimize the influence of reflections.
- **Free sound field**  
Using an anechoic chamber. All surfaces including the floor of such chambers are specially treated for sound absorption to minimize the influence of reflections.
- **Diffuse sound field**  
Using an echo chamber or type I test chamber. For sound insulation measurements, JIS prescribes the use of a so-called Type I chamber which provides an environment with uniform energy distribution.
- **Insulation measurement environment**  
Using a type II test chamber. This refers to a cuboid test chamber with specially adjusted reverberation times for specific frequencies.

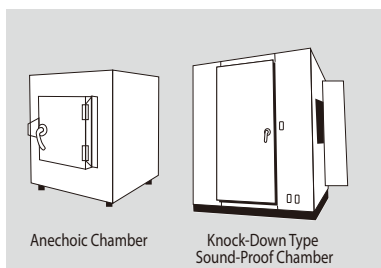

## 10

### Measurement of Sound Insulation and other Performance Parameters of Buildings

The acoustic properties of dividing walls, floor slabs, and other building elements are usually measured and evaluated according to the JIS specifications or methods recommended by the Architectural Institute of Japan, as listed below.

- **ISO 140-1**  
Acoustics - Measurement of sound insulation in buildings and of building elements - Part 1: Requirements for laboratory test facilities with suppressed flanking transmission
  - **ISO 140-3**  
Part 3: Laboratory measurements of airborne sound insulation of building elements
  - **ISO 140-4**  
Part 4: Field measurements of airborne sound insulation between rooms
  - **ISO 140-7**  
Part 7: Field measurements of impact sound insulation of floors
  - **ISO 140-8**  
Part 8: Laboratory measurements of the reduction of transmitted impact noise by floor coverings on a heavyweight standard floor
  - **ISO 717-1**  
Acoustics - Rating of sound insulation in buildings and of building elements - Part 1: Airborne sound insulation
  - **ISO 717-2**  
Part 2: Impact sound insulation
- To create the white / pink noise required for these measurements, the Random Noise Generator SF-06 is used. Suitable impact sound sources are the Tapping Machine FI-01A, the Bang Machine FI-02, and the Impact Ball YI-01. For evaluation complying with the standard stipulations, frequency analysis must also be performed. The required measurement results are reliably obtained with the Precision Sound Level Meter NA-28 in combination with the Building Acoustic Card NX-28BA. RION also offers the Multi-Channel Signal Analyzer SA-02 series and the Airborne/Floor Impact Sound Insulation Measurement Software AS-20PE5.

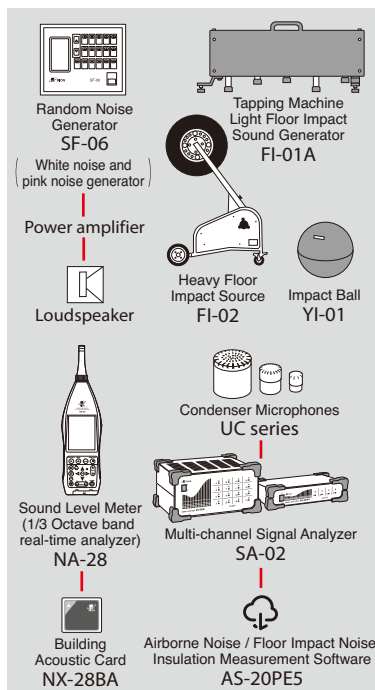

## 11

### Sound Intensity · Sound source location

Sound intensity is defined as the sound energy coming from a specific direction. By measuring sound intensity, it is possible to assess the sound power level of a sound source or measure the sound insulation performance of materials without having to use an anechoic chamber or other special equipment. It also is useful when examining from which part of the sound source a given noise emanates or which part of a material allows sound to pass through, and allows visualization of the results. For sound intensity measurement, the Sound Intensity Probe SI-31I is connected to a Multi-Channel Signal Analyzer of the SA-02 series, and the Sound Intensity Measurement Software AS-15PA5 is used. By choosing the 3-Axis Simultaneous Measurement Intensity Probe SI-33I, results for a three-dimensional grid can be obtained in a single operation. Using the sound source location software AS-16PA5, the sound incidence direction can be displayed in combination with a camera image.

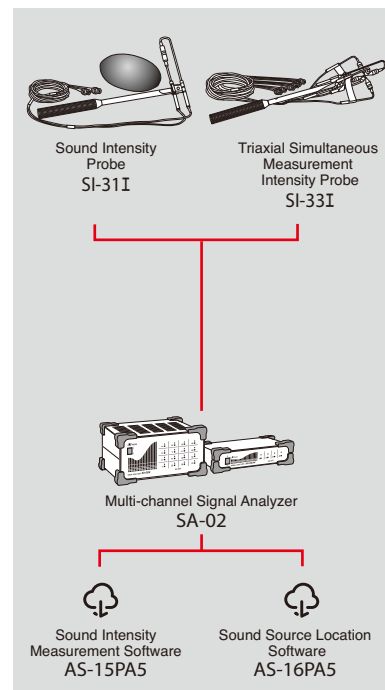

# 12

## Sound Power Level

Even if emitting noise of the same energy level, the actual ambient noise level in the vicinity of mechanical or electrical machinery, office equipment etc. will differ, depending on various conditions. When predicting expected noise levels associated with installation or removal of a given piece of equipment, or when assessing the equipment as a single noise source, it is important to determine the sound power level which represents the acoustic energy produced by the equipment per unit of time. The basic components that are required when configuring a system to measure the sound power level of a sound source are suitable microphones and preamplifiers, a Multi-Channel Signal Analyzer of the SA-02 series, and sound power level measurement software.

- Sound power level measurement system using a hemi-anechoic chamber
  - ISO 3745
  - ISO 3744

Calculates the sound power level according to the stipulations of the respective standard.

- Sound power level measurement system using a reverberation chamber, wide-band)
  - ISO 3741

Calculates the sound power level according to the stipulations of the respective standard

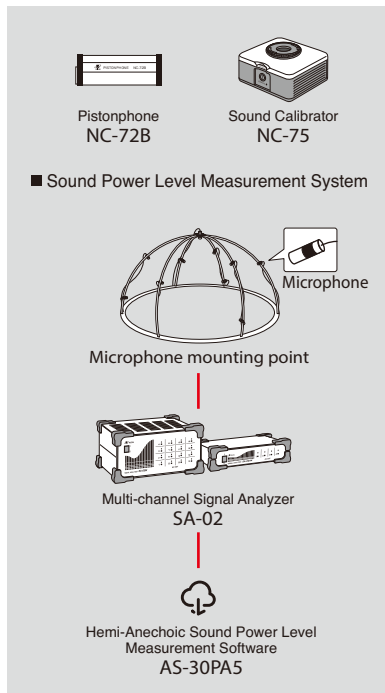

# 13

## Sound quality evaluation

In conventional sound evaluation measurements, frequency weighting using the "A" characteristics is commonly used for measurements intended to express the noise level. However, sound quality is increasingly gaining recognition as an aspect that is significant in evaluating the sound emitted by various kinds of products. Consequently, various parameters expressing sound quality such as loudness, roughness, and sharpness have come to be widely recognized as useful for evaluating sound. To measure these parameters, a system consisting of microphone and preamplifier, Multi-Channel Signal Analyzer of the SA-02 series, and sound quality evaluation software is suitable.

- Loudness
 

Loudness is an aspect that expresses the subjective volume of a sound as perceived by human hearing. ISO 532 defines the standard method which is used to calculate loudness as an evaluation parameter.
- Sharpness
 

Sharpness is an evaluation parameter that expresses the sharp metallic quality of sound in the high frequency range.
- Roughness
 

Roughness is an aesthetic evaluation parameter that expresses the perceived roughness dependent on modulation frequency, modulation rate, and sound pressure level changes.

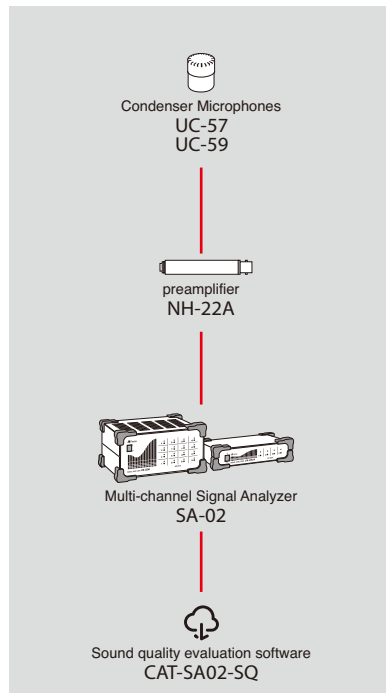

# 14

## Pure tone evaluation

The Tonal Audibility Calculation Program (Excel macro) can be used for pure tone evaluation. ISO 1996-2:2007- Annex C

- Assessing the audibility of tones in noise
 

The aim of the objective method is to assess the prominence of tones in the same way as average listeners based on the psychoacoustic concept of critical bands.
- Target sounds
 

Steady and varying tones, narrow-band noise, low frequency tones

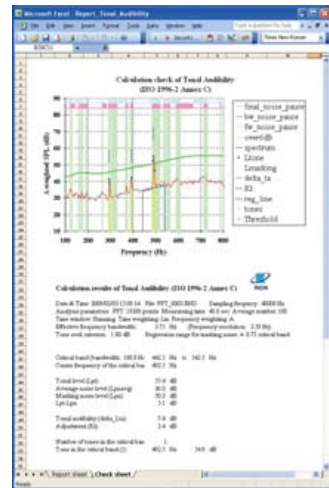

Tonal Audibility Calculation Program

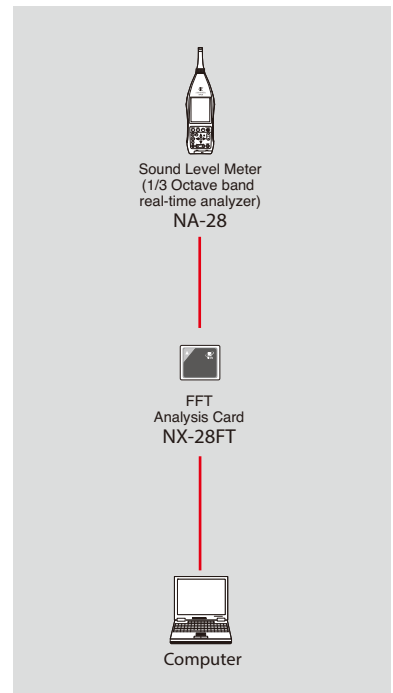

# Measuring Instrument Combinations

## 15

### Measurement of Mechanical Vibrations

Vibration measurements are most commonly carried out using PV series piezoelectric accelerometers as the sensor providing the input signal. Because there will be considerable differences in the magnitude of vibrations, depending on the measurement object, RION offers a wide range of accelerometers with different sensitivity levels and dimensions. Velocity information can be obtained by integrating the acceleration figures. Velocity can then be converted to displacement by further integration. The RION product lineup in the category of portable vibration meters includes the Pocktable Vibration Meter VM-63C, the Vibration Meter VM-82A, and the Vibration Analyzer VA-12 with built-in FFT analysis function. In the larger stationary type unit category, RION offers. The Vibration Meter VM-83, which also supports servo accelerometers, and the UV series charge amplifiers, such as the UV-15 and UV-16, which support a multi-channel configuration for simultaneous measurement.

To perform vibration analysis, the Vibration Analyzer VA-12, the Portable Multi-function Measuring System RIONOTE with FFT analysis\* and 1/1, 1/3, and 1/12\* octave band analysis\* capability, or the Multi-Channel Signal Analyzer SA-02 can be used.

When measuring vibration characteristics of machine parts and facilities, a vibration source is commonly used. Various types of containing, different output levels, are available to match the size of the object under test.

※ SA-02 only  
\* RIONOTE is optional

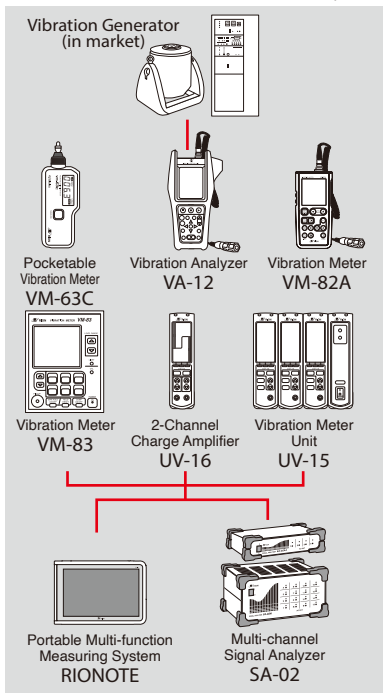

## 16

### Vibration Monitoring

Vibration monitoring is an important tool for detecting symptoms of impending problems in machinery and for implementing preventive maintenance. In the semiconductor industry and other sectors that require high accuracy manufacturing, vibration monitoring helps to improve yield and facilitates quality control. There are two basic patterns for vibration monitoring: continuous monitoring where vibration levels are automatically monitored on an ongoing basis and an alarm is triggered when a certain level is exceeded, and periodic monitoring at regular intervals combined with trend analysis designed to assess and manage the condition of the equipment.

RION offers a range of vibration accelerometers suitable for constant monitoring including general-purpose, high-temperature, water-proof and insulated types, and accelerometers with integrated preamplifiers. The Vibration Monitor UG-50 is suitable for such applications and offers the capability to output an alarm signal.

The Vibration Analyzer VA-12 and the Vibration Meter VM-83 can be connected to a computer for configuring a constant monitoring system.

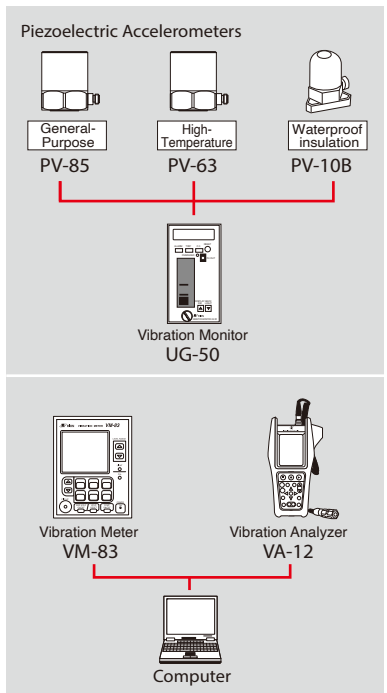

## 17

### Industrial Machinery Equipment Diagnosis

All machines use either rotation, reciprocal movement, impact, or some other form of motion to achieve their purpose. If a problem occurs somewhere, unwanted vibration will increase. Normally, simple diagnosis is carried out on a regular schedule to establish the normal/abnormal status of equipment. When a problem is detected, precision diagnosis is performed to obtain in-depth knowledge about the condition.

Products suitable for simple diagnosis include the General-Purpose Vibration Meter VM-82A and the Pocktable Vibration Meter VM-63C. These allow checking multiple pieces of machinery within a short time, using simple procedures.

For detailed equipment diagnosis, the Vibration Analyzer VA-12 with integrated FFT analysis function or the RIONOTE Multifunction Measurement System together with the Vibration Analysis Program SX-A1VA are well suited.

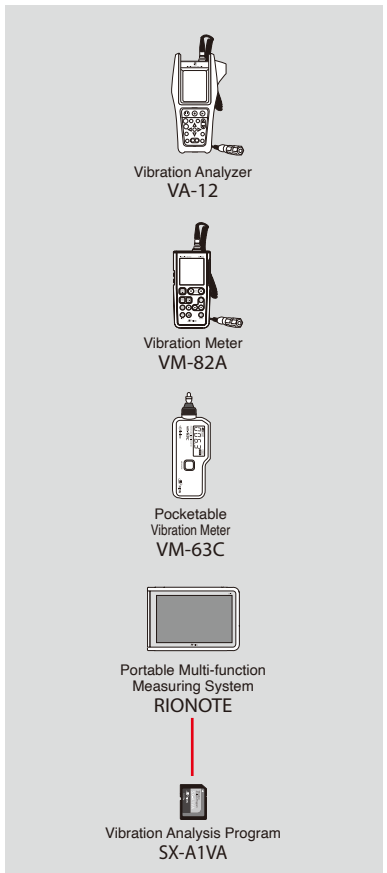

# 18

## Whole-Body Vibration Measurement

Vibrations are transmitted to the human body via the feet when standing, via the posterior when seated, and via the back when leaning on a backrest.

The influence of such vibrations on humans can be evaluated under many aspects including vibration perception, comfort, health hazards, and motion sickness. ISO 2631 specifies many different frequency compensation circuits for judging vibration depending on direction as well as rotational vibration. ISO 2631 compliant measurements can be made by using the 3-Axis Vibration Meter VM-54 combined with the Whole Body Vibration Card VX-54WB/VX-54WB1 or Marine Vibration Card VX-54WS.

For measurement of seat vibrations and evaluation of ride quality, the Seat Measurement Accelerometer PV-62 is mounted to the measurement target and connected to the 3-Channel Preamplifier VP-80, as shown in (Figure 1).

For evaluation of buildings and ride quality in ships, vibration measurement can also be carried out with the Accelerometer PV-83CW (supplied with VX-54WS), as shown in (Figure 2). When making motion sickness related measurements, the frequency range from 0.1 to 0.5 Hz is relevant. A suitable measurement setup consists of the Servo Accelerometer LS-10C for detecting vibrations, connected to Multi-Channel Analyzer SA-02 via the Servo Accelerometer Power Supply LF-20 (Figure 3).

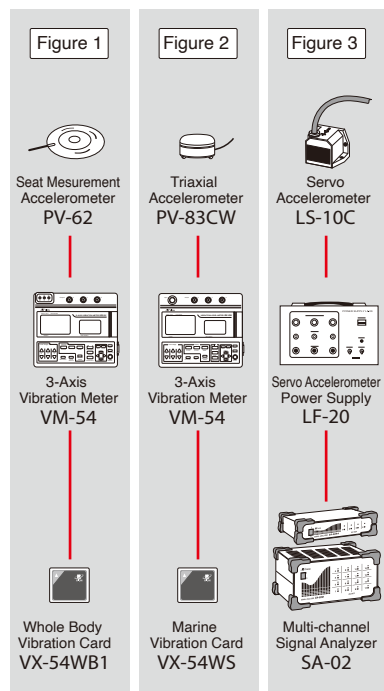

# 19

## Hand-arm Vibration Measurement

In the work environment, hand-arm vibration leading to an ailment called Raynaud's disease can pose a serious problem. This kind of vibration-related ailment, where blood circulation in the hand and fingers decreases causing them to appear white, is often due to the use of chain saws, rock drilling machines and other hand-held or hand-guided power tools that produce vibrations. ISO 5349 compliant quantitative evaluation of such vibrations is possible by using the 3-Axis Vibration Meter VM-54 together with the Hand-Arm Vibration Card VX-54WH.

To devise measures for preventing such vibrations, the vibration exposure can be determined by a Triaxial vibration component measurement performed on the handle of the tool in question. For this purpose, the Triaxial Accelerometer PV-93/97C/97I or multiple single-axis accelerometers PV-90B/90I are combined with the 3-Channel Preamplifier VP-80 and connected to the VM-54 in which the Hand-Arm Vibration Card VX-54WH has been installed. It is also possible to measure the hand-arm vibration using the Multi-Channel Signal Analyzer SA-02 series with the software CAT-SA02-HT.

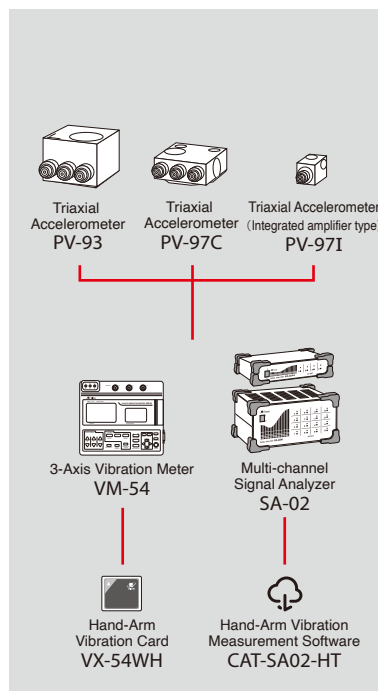

# 20

## Mode Analysis

Analyzing the state and type of vibrations occurring in objects is an important approach that helps to detect early signs of problems, prevent breakdowns, and reduce the emission of noise. Test mode analysis is a method that uses vibration modes for creating models of vibration patterns. It is especially useful in exploring causes and countermeasures for resonance phenomena and other vibration and noise related problems.

An impulse hammer is used to create a controlled impact, and the resulting vibrations are measured in 3 directions on the entire surface, using suitable accelerometers such as the PV-90B/91C. A Multi-Channel Analyzer of the SA-02 series and the Mode Analysis Software ME Scope are then employed to perform the mode analysis.

A large number of transfer function peaks can provide information about normal mode vibration frequency, mode shape, attenuation coefficient and other mode parameters.

Separate structure change simulation software makes it possible to study anticipated vibration mode changes that will result from physical changes to the machinery or the supporting structure. External force response analysis is also possible.

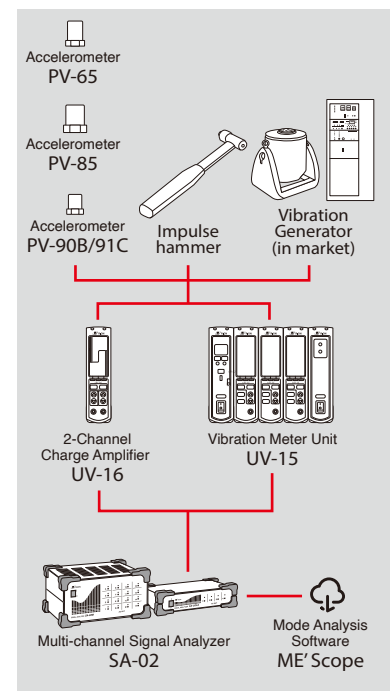

# 21

## Tracking Analysis System

Nearly all kinds of rotating machinery such as car engines and electric motors produce vibrations that depend on their revolution speed and gear ratio. Such vibrations then become the source of noise which contains predominantly frequency components resulting from the vibrations. Because the revolution speed of rotating machinery changes over time, it is effective to perform frequency analysis in sync with the changing revolution speed. This process is called tracking analysis. There are several types of tracking analysis, as described below.

- **Harmonics ratio analysis**  
Using the basic rotation speed as the fundamental, the higher-order harmonics components (2nd order, 3rd order...) are analyzed according to the rotation speed change.
- **RPM tracking analysis**  
This is a special form of harmonics ratio analysis, where the level change at one frequency or harmonic is plotted on a graph pegged to the rotation speed change.
- **Mode circle**  
Another form of harmonics ratio analysis, where the amplitude and phase change at one frequency or harmonic according to the rotation speed change is plotted on a coordinate system.
- **Spectrum map**  
The change in spectral pattern when the rotation speed is changed is plotted continuously and the level change is analyzed in a macro reference frame.
- **Campbell diagram**  
The rpm dependent spectral change is plotted on a graph where the amplitude value is represented by the diameter of a circle.

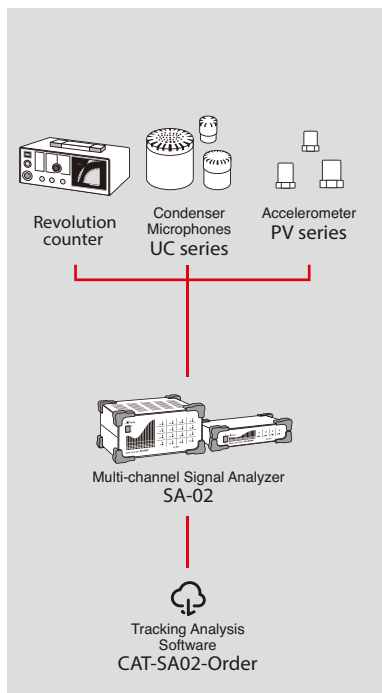

# 22

## Measurement of Low-Frequency Microvibrations

Low-level, low-frequency vibrations must be measured in various instances, such as when measuring minute floor vibrations to assess the occupation comfort of a building, checking for microvibrations in a clean room for semiconductor manufacturing or testing the efficiency of vibration damping systems for precision machinery. The Servo Accelerometer LS-10C/40C, Vibration Level Meter VM-57 or the high-output accelerometer PV-87 in combination with the Vibration Meter VM-83 are suitable for such purposes. It is also possible to perform frequency analysis and evaluation with the Multi-Channel Signal Analyzer SA-02 series, Portable Multi-function Measuring System RIONOTE\*. The evaluation of floor vibrations uses the floor response waveform for determining vibration frequency, displacement, velocity, acceleration and attenuation constants. These are then compared to reference curves for actual evaluation. For testing the efficiency of vibration damping systems, sensors are mounted on the floor and to the mounting bed of the object under test.

\* RIONOTE is optional (FFT analysis program or 1/3 Octave analysis program can be chosen.)

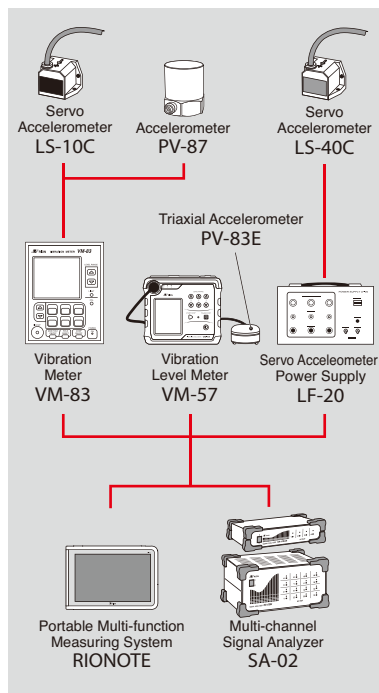

# 23

## Vibration measurement with sound level meter

By connecting a vibration sensor to the sound level meter, measurement of vibrations becomes possible.

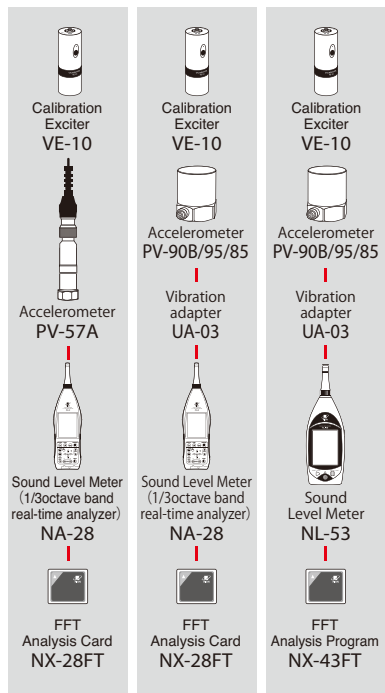



# Outline NOISE AND SOUND LEVEL METERS

## Sound and Noise

What is commonly called "sound" is actually vibrations of air. Various objects, when rubbed or tapped, can become sound sources. The vibration of the sound source object causes the adjacent air to vibrate and these vibrations are transmitted to the ear where they are perceived as sound.

In our everyday environment, there are many different kinds of sounds, but humans do not respond to all of these. Rather, we subjectively make decisions and focus only on certain sounds that we want to hear. Other sounds that are not important, often inconvenient or disturbing, are sounds that are undesirable or unnecessary. Such sounds are called "noise". Rather than containing certain physical properties, what defines noise is a subjective characteristic that is specific to the listener. Sound that is too loud, unpleasant, or that draws attention in a certain direction is commonly judged as noise.

## Physical and Sensuous Value of Sound

The physical magnitude of sound is sound pressure, representing tiny changes in atmospheric pressure, the unit measured by Pascal (Pa). The range of sound pressure that can be detected extends from 20 $\mu$ Pa to 200 Pa, a difference of a factor of as much as 10 million times. The loudness of a sound as perceived is proportional to the logarithmic value of the sound pressure. The sound magnitude is expressed as a sound pressure level in decibel (dB), using the smallest sound that can be heard (20 $\mu$ Pa) as reference, and covering a range from 0 dB to 140 dB.

The sensitivity of the human ear differs depending on the frequency of the sound. The same sound pressure can be perceived differently at different frequencies. When a certain sound is perceived equal to the sound pressure level PdB at 1 kHz, the loudness level of that sound is said to be Pphon. Figure 2 shows the relationship between the loudness level of a pure tone and its frequency. The curves in this graph are called equal loudness curves. As can be seen from the graph, the physical magnitude of a sound and its subjective magnitude are not the same. Rather, there is a complex relationship between the two.

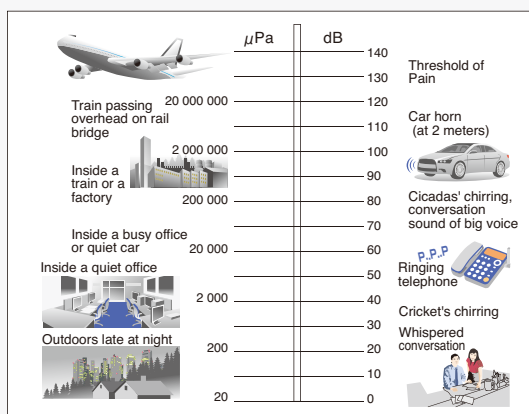

Fig. 1 Sound pressure and sound pressure level

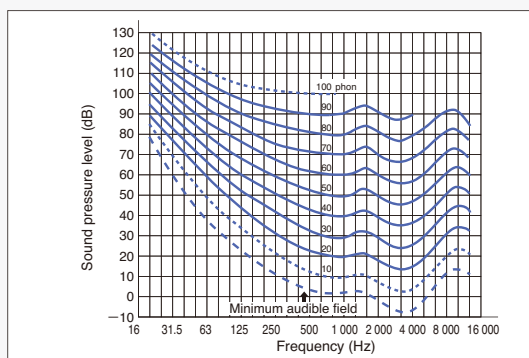

Fig. 2 Equal loudness curves of sound

## Sound Level and Sound Level Meter

A reverse curve corresponding to the equal loudness curve at 40 phon (ISO 226 : 1987) is applied to the sound pressure.

The resulting level is called sound level and is expressed in dB.

However, the equal loudness curve in ISO 226:2003 is close to 60 phon.

### What is equivalent continuous sound level $L_{eq}$ ?

Equivalent continuous sound level  $L_{eq}$  is used for environmental noise evaluation.

#### Equivalent continuous sound level

The equivalent continuous sound level  $L_{eq}$  is the constant sound level which has the total sound energy equivalent to the energy of an actual fluctuating sound produced over a given period of time. As an example, consider the illustration at right. In the top graph, the sound level fluctuates from 47 to 60 dB within the time interval  $t_1$  to  $t_2$ . When the total energy of this sound is equated to a constant sound level over the same period, the 53 dB value (bottom graph) is obtained.

#### $L_{eq}$ measurement

The equivalent continuous sound level can be automatically calculated by a sound level meter with built-in  $L_{eq}$  function.

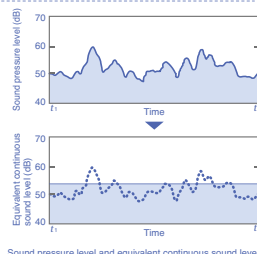

## Standards of Sound Level Meters

Sound level meters are divided into two categories: Class 1 and Class 2. There is a difference in performance between these classes. Performance specifications and test methods of sound level meters are specified in the international standards IEC 61672 series. Two performance categories, Class 1 and Class 2, are specified in the standard. Basically, specifications for Class 1 and Class 2 sound level meters have the same design goals and differ in the tolerance limits. Tolerance limits for Class 2 specifications are greater than, or equal to, those for Class 1 specifications.

Some common terms used having with special meanings and relating to sound level meters are listed below.

### ① Frequency weightings

The different sensitivity of the human ear at different frequencies is represented by the "A" and "C" weightings as shown in Figure 3. When measured with the "A" weightings, the result is close to the subjective sound level impression. When measured with the "C" weightings, the result is close to the sound pressure level (physical quantity).

### ② Time weightings

Sound level is obtained by averaging the signal corresponding to the sound pressure raised to the second power. Two kinds of time weightings are used, which differ in the time constant used for averaging: F (Fast, time constant 125 ms) and S (Slow, time constant 1 s). For normal noise measurements, the F-time weighting is used. In some countries, a third characteristic called Impulse is used for the measurement of impulsive and impact noise.

### ③ Type approval and test certification (In Japan)

Type approval refers to a process by which the government tests sound level meters provided by domestic manufacturers and importers and ascertains that their construction and performance is in accordance with the stipulations of the Measurement Act. When a sound level meter model has been type approved, most items can be omitted during testing for individual product certification.

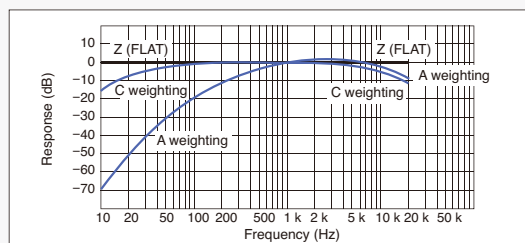

Fig. 3 Frequency weightings of sound level meters

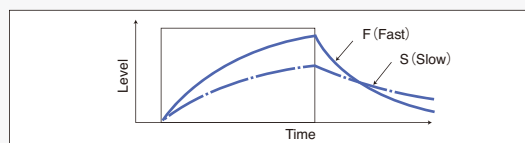

Fig. 4 Time weightings of sound level meters

## Sound Level Meter Types

Many different kinds of sound level meters exist. The optimum device to be chosen will depend on the purpose of the measurement, the required accuracy, and the data processing method that is to be employed. Some of the main categories are listed below:

### ① Sound Level Meter class 1/class 2 (NL series)

These are the most common types of sound level meters, whose performance are defined by the applicable standards. The difference is in accuracy.

### ② High-Precision Measuring Amplifier

A wide range of frequency and level range settings make this product suitable for many different measurements.

### ③ Sound Level Meter with Analysis Functions (NA-28, NL-63 with NX-63RT/43FT, NL-53/43 with NX-43RT/43FT)

These are portable sound level meters with real-time analysis or FFT analysis functions.

### ④ Environmental Noise Monitor

This type of device performs data processing according to standards and regulations. It serves for measurements as well as for observation and monitoring of noise.

### ⑤ Sound Level Meter (With low-frequency sound measurement function). (NL-63 with NX-63RT)

Allows G-weighted sound level measurement in conjunction with 1/3 octave real-time analysis.

### ⑥ Sound Level Display

Designed for mounting in outdoor urban locations, this type of device can display the ambient sound level at a specific point.

# VIBRATION AND VIBRATION METERS

## Importance of Vibration Measurement

Normally, vibrations arising in an industrial or residential environment are clearly an unwanted phenomenon, except in some special cases. Such unwanted vibrations are not only unpleasant to humans but they can also shorten the life of machinery, impair product quality, and cause defects and breakdowns. Sound arising from vibrations is also an environmental problem. Finding solutions to the multi-faceted problems presented by vibrations therefore is an important and pressing task. RION vibration meters are effective tools used to collect information in a wide range of fields. These include the maintenance, monitoring and testing of machinery, product design and research, quality control, noise and vibration countermeasure research, evaluation of tools and vehicles according to labor environment and hygienic regulations, vibration pollution control, and seismographic data collection and disaster prevention.

## How to Measure the Magnitude of Vibrations

There are three vibration parameters which can be used to express the magnitude of vibration: displacement, velocity, and acceleration. Which of these factors is used depends on the type of vibration and the measurement objective. The relationship between them in the case of a sine wave vibration is shown in the illustration below.

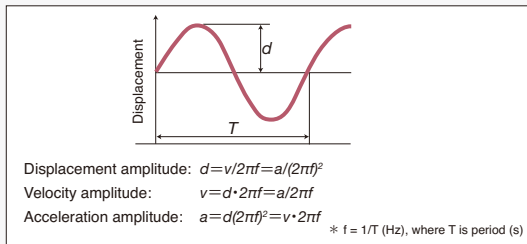

Units used for the magnitude of vibration are listed in the table below.

|                        |   |
|------------------------|---|
| Displacement           | mm, $\mu\text{m}$ ( $1 \mu\text{m} = 10^{-3} \text{ mm}$ )                  |
| Velocity               | mm/s  |
| Acceleration           | $\text{m/s}^2$ , $\text{cm/s}^2$ Gal ( $1 \text{ Gal} = 1 \text{ cm/s}^2$ ) |
| Vibration acceleration | $\text{dB}(\text{re} \cdot 10^{-5} \text{ m/s}^2)$ : JIS                    |

## Vibration Meters for Mechanical Vibrations

When vibration meters are used for measuring machine vibrations, a suitable accelerometer must be selected depending on the type of mechanical. Accelerometers designed for low frequencies measure low acceleration levels and, thus, are highly sensitive. However, their larger size and mass result in low resonance frequency when mounted. Accelerometers for high frequency measure high acceleration levels and are normally compact and lightweight with low sensitivity. RION offers a selection of piezoelectric accelerometers, covering a wide frequency range. By combining an accelerometer with a vibration meter that is designed to make the best use of its characteristics, a wide range of measurements can be performed with optimum efficiency. Piezoelectric accelerometers are normally used for measuring vibrations with a frequency of more than 1 Hz. This type of accelerometer has good high-frequency characteristics and is especially suited for measuring vibrations in the upper frequency range. Major applications are vibration monitoring and diagnostic checks of mechanical installations in industrial plants. Piezoelectric accelerometers generate a certain amount of low-frequency noise when ambient temperatures change (so-called pyronoise). Depending on the application, the accelerometers must therefore be protected from temperature changes. When velocity and displacement to be used for evaluation are obtained by integrating acceleration, pyronoise will be evaluated as integral products, pyronoise will be amplified and must therefore be given special consideration. With the exception of types containing, piezoelectric accelerometers require a charge amplifier.

## What is the piezoelectric accelerometer?

Certain types of crystals will generate an electrical charge on their surface when pressure is applied. The amount of the charge is proportional to the external force. This phenomenon is called the piezoelectric effect, and the vibration acceleration sensor called a piezoelectric accelerometer makes use of it. Piezoelectric accelerometers can be made compact and lightweight, allowing them to cover a wide vibration frequency range. Accuracy and reliability are also very good, and handling is simple. Thanks to these characteristics, piezoelectric accelerometers are widely used for many general applications, and also serve as reference accelerometers. There are two types of piezoelectric accelerometers, namely shear-type and compression-type, which differ in the way the piezoelectric element is used.

Fig. 1 Piezoelectric accelerometer types

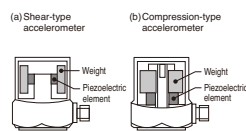

Fig. 2 Principle of shear-type accelerometer



### Shear-type accelerometer

The accelerometer is constructed in such a way that the piezoelectric element is subjected to a shear force. Sensitivity is high, which allows for small dimensions. Pyronoise (pyroelectric output) caused by temperature changes is low, which is advantageous for measuring low-level vibrations and vibrations in the low frequency range. This type is useful for monitoring vibrations in machinery and buildings, and for seismometer applications.

### Compression-type accelerometer

This type of accelerometer employs a weight on top of the piezoelectric element. The structure is simple and mechanical strength is high, making it suitable for high acceleration levels and shock measurements.

- When using a piezoelectric accelerometer with a TEDS compliant measuring device, sensitivity setting must be performed.
- In case of a TEDS compliant piezoelectric accelerometer, sensitivity setting is not required.

## Measurement of Vibration Pollution (Vibration Level Meter)

The evaluation of vibrations considered as environmental pollution uses the vibration level (dB), which is based on the pattern of human sensitivity to vibration. This is the same principle employed for the measurement and evaluation of sound pressure levels considered noise. Compensation according to human sensitivity characteristics is applied to the measured physical quantity (acceleration in the case of vibration pollution), and the resulting value forms the basis of evaluation. The illustration below shows the frequency response that is stipulated by JIS C 1510 for vibration level meters.

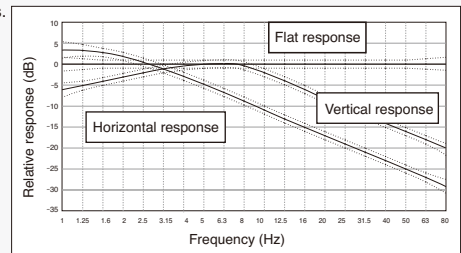

Allowable response range for vibration level meters

## Equipment Diagnosis

### ① Types of equipment maintenance

Depending on the importance of the equipment, there are various kinds of maintenance, required. In each case, the objective is to achieve maximum efficiency at minimum cost.

#### ● Breakdown Maintenance (BM)

The principle here is to repair equipment when it breaks down.

#### ● Time-Based Maintenance (TBM)

Parts are replaced at regular intervals regardless of breakdown and schedules are established for routine checks, disassembly and repairs. This is a kind of Preventive Maintenance (PM).

#### ● Condition-Based Maintenance (CBM)

The operational condition of machinery is regularly measured to determine the degree of deterioration or the existence of other factors equipment breakdown, Mechanical Checks, disassembly, repairs, and parts replacement are then carried out as a result.

This is a kind of predictive maintenance (PRM).

### ② Equipment diagnosis by vibration measurement

The vibration method diagnosis by vibration measurement involves measuring vibrations of the equipment in operation for early detection of problems and taking optimum countermeasures. This is effective for key equipment directly linked to manufacturing facilities, particularly rotating (machines).

### ③ Frequency response on vibration parameter

Depending on the vibration frequency, each amplitude response of displacement, velocity and acceleration will be different. During equipment diagnosis, the following distinctions must be made; It is important to have a clear understanding of which type of vibration is likely to increase and should use an appropriate vibration parameter depending on abnormality. In some cases, both velocity and acceleration may have to be measured.

### ④ Diagnosis methods

#### ● Simple diagnosis

For this type of diagnosis, vibration measurements are carried out periodically by service personnel; The trend management of measurement results are then used for preventive maintenance of equipment.

Suitable products include VM-82A, VM-63C, VA-12, SX-A1VA etc.

#### ● Precision diagnosis

Vibration signals are processed using FFT analysis or other similar techniques to identify problem areas and to initiate checks and repairs.

Suitable products include VA-12, SX-A1VA etc.

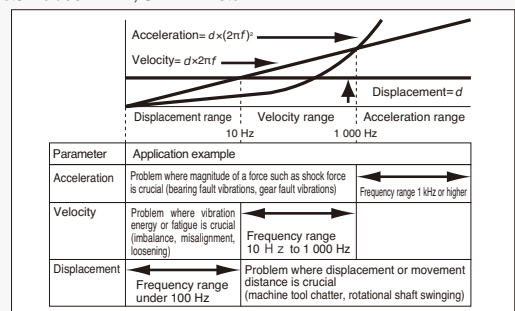

Vibration parameter

# Outline FREQUENCY AND FREQUENCY ANALYZERS

## Frequency Analysis and Frequency analyzers

Normally, sound and vibration phenomena occur with specific frequency characteristics. Multiple frequency components coexist in complex patterns. Determining the respective levels of these frequency components is called frequency analysis. Countermeasures for noise or vibrations will not be effective over the entire frequency range. Therefore, target values and evaluation criteria must be set separately for the various frequency bands.

### Frequency analysis classification

Frequency analyzers can be grouped in various categories, according to usage purpose, as listed in Table 1.

Table 1 Frequency analysis types

| Purpose  | Filter   | Frequency analyzer   |
|--|--|--|
| <ul style="list-style-type: none"> <li>● Evaluation of sensory impact of sound and vibration</li> <li>● Evaluation of countermeasures</li> <li>● Materials development and evaluation</li> </ul> | Constant ratio<br>1/1 octave band<br>1/3 octave band | NA-28<br>SA-02<br>SX-A1RT (RIONOTE)<br>NX-63RT (NL-63)<br>NX-43RT (NL-43/NL-53)<br>VX-57RT (VM-57) |
| <ul style="list-style-type: none"> <li>● Identify noise and vibration phenomena</li> <li>● Noise and vibration countermeasures</li> <li>● Materials development and evaluation</li> </ul>        | Constant width<br>FFT<br>(narrow-band analysis)      | NX-28FT (NA-28)<br>SX-A1FT (RIONOTE)<br>SA-02<br>NX-43FT (NL-43/53/63)<br>VA-12                    |

#### ① Frequency analyzers

Devices for the frequency analysis of sound and vibrations can be divided into real-time analyzers and FFT analyzers, depending on their purpose. Figure 1 shows the analysis results of the same signal waveform processed on 1/3 octave band analysis and FFT analysis. A real-time analyzer employs a number of bandpass filters with a constant ratio (1/1, 1/3, or 1/N octave bands). Frequency analysis performed with such a device serves mainly to assess the sensory impact of sound or vibration phenomena. The FFT analyzer is calculated by constant width band. Frequency analysis performed with such a device serves mainly to assess the physical magnitude of sound or vibration phenomena.

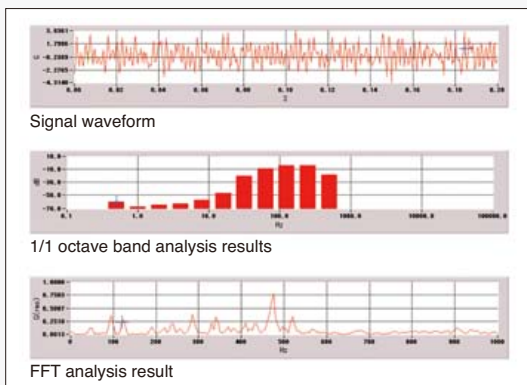

Fig. 1 1/1 octave band analysis results, FFT analysis result

#### ② Constant ratio type filter and constant width type filter

Filters used in frequency analyzers are of two types: constant ratio and constant width. In a constant ratio filter, the width of the passband varies in proportion to the center frequency while in a constant width filter, the passband width is always the same. Figure 2 illustrates the underlying principle. When a logarithmic scale is used for the frequency axis, the bandwidth of the constant ratio filter is shown as a constant, while the bandwidth of the constant width filter is shown as becoming narrower towards higher frequencies. When plotting frequency analysis results on a graph, it is therefore common to use a logarithmic frequency axis for a constant ratio filter and a linear scale for a fixed.

#### ③ Filter specifications

Filter characteristics for octave band and 1/N octave band filters (Frequency Analyzers) are specified in JIS C 1513-1. Internationally, the IEC 61260-1 is used. The fact that filter specifications are governed by international standards means that data can be easily compared. However, for FFT analyzers there are no JIS or international standards. Therefore, different analysis results may be obtained depending on the performance and settings of the analyzer in use.

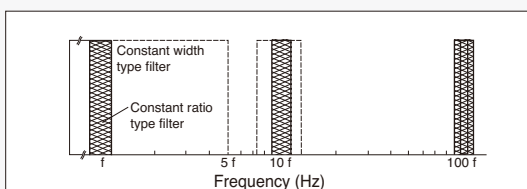

Fig. 2 Bandwidth representation for constant ratio and constant width filter on logarithmic scale

### Different Ways of Using Frequency Analyzers

#### ① Real-time analyzer

The most commonly used method for assessing the sensory impact of noise and vibration and for evaluating countermeasures is 1/1 octave and 1/3 octave analysis. Averaging can be carried out using the same frequency weighting and time weighting as the sound level meter or vibration level meter. This makes it possible to evaluate the actual impact that the noise or vibration phenomenon has on humans. The technique is used for many different tasks such as sound insulation measurements for architectural acoustics, evaluation of indoor noise, sound power level measurements, evaluation of building materials, sound quality evaluation, and propagation characteristics measurement.

#### ② FFT analyzer

An FFT analyzer serves for assessing the physical aspects of sound or vibration phenomena and for devising suitable countermeasures. General applicability is good because analysis can be carried out in the time domain as well as in the frequency domain. Frequency resolution is excellent, which is essential for locating the sources of noise and vibrations, and the relationships between signals in multiple channels (for example, sound and vibration) can also be explored. FFT analyzers are extensively used in sound and vibration analysis of cars, machinery, computers, electric home appliances, etc., and in the development and evaluation of damping materials. Measurement types include mechanical impedance, mode analysis, intensity measurement, tracking analysis, propagation characteristics measurement, and sound quality measurement. FFT analyzers are indispensable tools in the fight against noise and vibrations.

### FFT and Signal Processing

#### ① FFT analyzer

The result of FFT (Fast Fourier Transform) analysis is characterized by constant bandwidth. In the input of an FFT analyzer, a low-pass filter (anti-aliasing filter) is used to remove signal components other than those of the bandwidth to be analyzed. Then, the A/D circuit converts the input into a digital signal, and time window processing is carried out. Finally, FFT processing is performed, resulting in discrete frequency analysis.

#### ② Signal processing

The FFT analyzer can also provide amplitude information and phase information. In the time domain, this includes time waveform, auto-correlation, cross-correlation, amplitude probability density function. In the frequency domain, spectrum, dual-channel cross-spectrum, transfer function, and coherence function can be calculated. Intensity measurement, as well as 1/1 and 1/3 octave band analysis (octave synthesis), can be carried out, and mode analysis and tracking analysis for the entire system are possible.

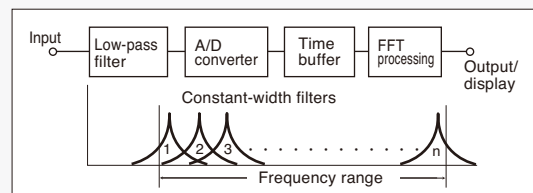
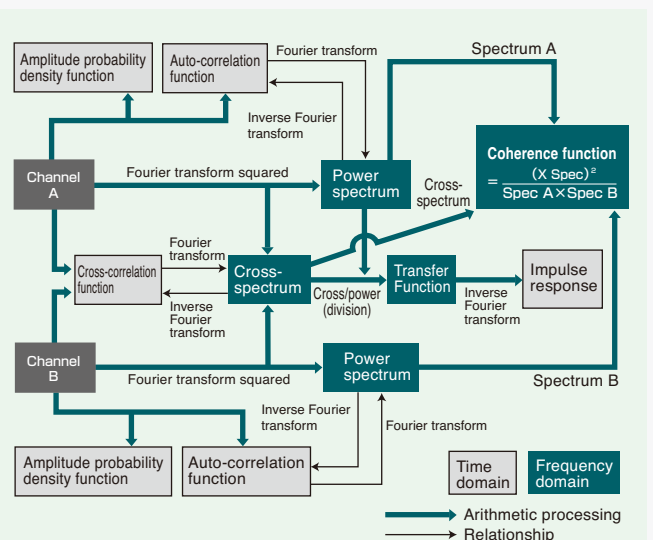

Fig. 3 FFT spectrum analyzer (spectrum analysis)

table 2 Relationship between various FFT analyzer functions



# Outline RECORDING SOUND AND VIBRATION

## Sound and Vibration Level Recording

- ① For recording the level of sound and vibrations, a device conforming to JIS C 1512 Level recorders for recording sound level and/or vibration level is used. Such a device uses the output signal of a sound level meter or vibration level meter.  
The operation characteristics of the recording pen can be selected.

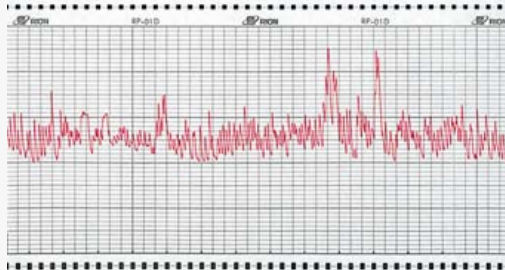

Sound level recording on Recording Paper RP-01D

- ② When a sound level meter or vibration level meter with integrated SD card slot is used, level data can be directly recorded on a memory card, thereby realizing long-term recording. The data stored on the memory card can later be processed on a computer, either using dedicated software or a general application. Sound level and vibration level waveform information can be displayed and stored. Various other Functions are also possible (NL-43/53/63, VM-55).

■ Memory card capacity and storage time for sound or vibration level (instantaneous value store every 100 ms)

|        | Sound level meter | Vibration level meter (3-axis) |
|--------|-------------------|--------------------------------|
| 512 MB | 2.4 days          | 2.5 days                       |

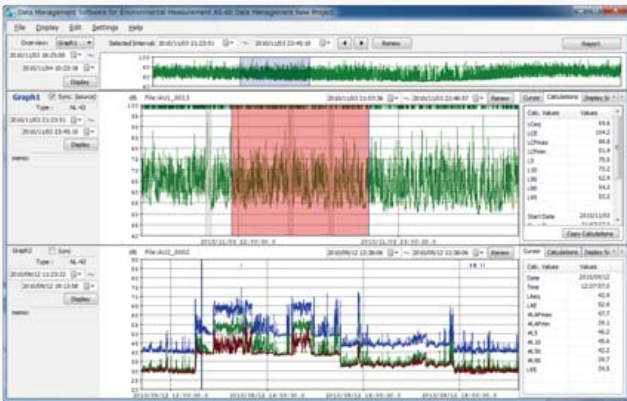

Data management software for environmental measurement AS-60

## Sound and Vibration Waveform Recording

- ① Sound pressure waveform and vibration acceleration waveform information can be recorded for analysis making it possible to examine the transient characteristics of, for example, impulsive noise and vibration from blasting, gun fire, collision impact and other such phenomena. Waveform peak values can be measured, and frequency analysis performed.

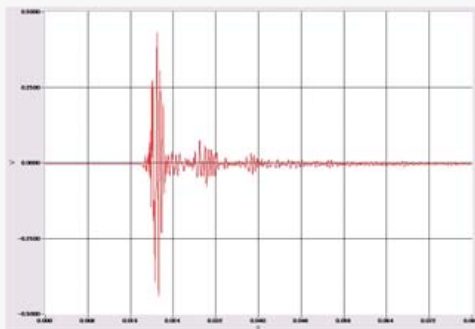

Vibration waveform recording example (forging machine)

- ② Suitable products for waveform recording are waveform recorders (NX-28WR/NX-43WR, SA-02/RIONOTE) or data recorders (DA-21). These products use SD cards as recording media. The recorded data can be played back and post-processed with analyzers or analyzer software and recorders.

- ③ Waveform data recorded on a memory card can be displayed and analyzed using dedicated application software (such as the Waveform Analysis Software AS-70). Recorded sound data (WAVE files) can be played back as real sound using Media Player or other suitable software.

### ■ DA-21

|                    |   | Frequency range (Hz) |            |            |           |           |          |
|--------------------|---|----------------------|------------|------------|-----------|-----------|----------|
|                    |   | 100                  | 500        | 1 000      | 5 000     | 10 000    | 20 000   |
| Number of channels | 1 | 1066 h 40 m          | 213 h 20 m | 106 h 40 m | 21 h 20 m | 10 h 40 m | 5 h 20 m |
|                    | 2 | 533 h 20 m           | 106 h 40 m | 53 h 20 m  | 10 h 40 m | 5 h 20 m  | 2 h 40 m |
|                    | 3 | 355 h 32 m           | 71 h 06 m  | 35 h 33 m  | 7 h 06 m  | 3 h 33 m  | 1 h 46 m |
|                    | 4 | 266 h 40 m           | 53 h 20 m  | 26 h 40 m  | 5 h 20 m  | 2 h 40 m  | 1 h 20 m |

Reference for maximum recording time with 2 GB SD card

Sampling frequency: frequency range × 2.56 (or 2.4)

※ Use only RION supplied cards for assured operation.

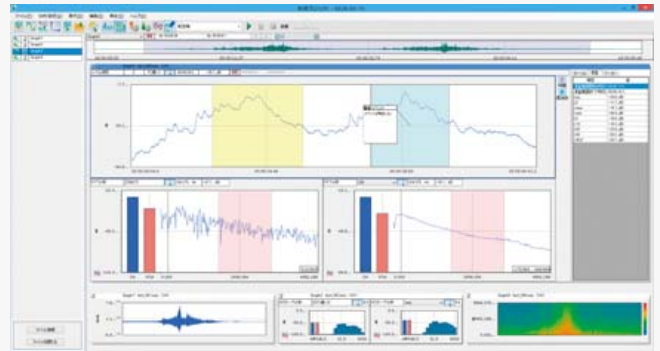

Waveform analysis screen example

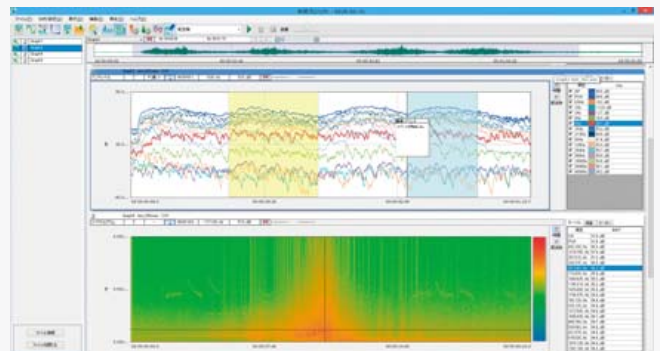

Waveform analysis screen example

## Sound Level/Vibration Level Measurement Paper

- ① Recording Paper for level Recorder RP-01D (for 1ch)

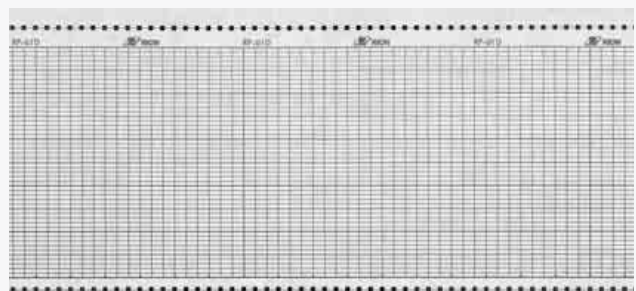



# Knowledge in a Nutshell

## What is percentile noise level?

These are evaluation quantities used to measure sound occurrence which is irregular and where its level fluctuates drastically. A certain time period is considered for the measurement. When the sound level exceeds a certain level for  $N$  % of the time under consideration, its level is called the  $N$  percentile level. For example, if the measurement time is 10 minutes and 55 dB was exceeded for a total of 5 minutes, 55 dB is the 50 % percentile sound level (median value). If 55 dB was exceeded for a total of 30 seconds, 55 dB is  $L_5$  (5 % percentile level).

## What is sound in the low frequency range like?

The range from 1 Hz to 100 Hz is commonly referred to as the low frequency range. In particular, acoustic waves between 1 and 20 Hz, i.e. below the threshold of hearing, are called infrasound or subsonic waves. The NL-63 is a sound level meter that covers not only the range of audible noise but also allows measurement of the low-frequency sound range.

Noise in the audible range is often described as noisy or clamorous, referring directly to the quality of the sound, while low-frequency energy in the barely audible or inaudible range is usually described in psychological terms such as being unpleasant or oppressive. Normally, with a 10 Hz infrasound, a sound pressure level of 90 dB or more is said to be noticeable to humans, while at 20 Hz, the threshold is 80 dB. At higher levels, the phenomenon is experienced negatively, and the psychological terms mentioned above tend to be used.

## What is G weighting?

To evaluate the psychological and physiological effects of infrasound in the range from 1 to 20 Hz, the G weighting curve was established as ISO 7196 in March 1995. The curve is referenced to 10 Hz and uses the threshold values for human perception of infrasound. The principle is the same as that for A characteristics weighting employed in sound level meters, which uses 1 kHz as reference and simulates the characteristics of human hearing in the audible range.

## What is frequency analysis?

Sound and vibrations commonly have complex waveforms consisting of many different frequency components. The process of dividing such a complex waveform into discrete frequency components in order to examine the nature of the sound or vibration is called frequency analysis. Commonly used types of frequency analysis are 1/1, 1/3 octave band analysis, and FFT analysis.

## What are 1/1 octave band analysis and 1/3 octave band analysis?

Our perception of the pitch of a sound is mainly determined by its frequency. The perceived difference in pitch between sounds is not proportional to the difference in frequency but to the ratio of the frequency. The bandpass filters used for frequency analysis come in two types: fixed ratio filters, where the ratio between the upper boundary frequency and lower boundary frequency of the filter is constant, and fixed width filter, where the difference between the upper boundary frequency and lower boundary frequency of the filter is constant. (For details, see page 35.) Analysis with the aim of evaluating noise normally uses fixed ratio filters (since these can more easily be made to approximate the subjective hearing impression of humans. A frequency ratio of 2 is called an octave, and a set of filters where the upper boundary frequency is 2 times the lower boundary frequency is called a 1/1 octave bandpass filter. The nominal center frequencies of a 1/1 octave band filter are 31.5, 63, 125, 250, 500, 1 000, 2 000 Hz, and so on. In other words, adjacent filters have a ratio of 2. When detailed frequency is required, 1/3 octave filters are used, which are centered on the frequencies 31.5, 40, 50, 63, 80, 100, 125 Hz, etc. Here, the adjacent filters have a ratio of 1.25 (one third of an octave).

## What is FFT (Fast Fourier Transform) analysis?

This method uses an algorithm called "Fast Fourier Transform" to divide a component signal with a seemingly irregular time cycle into a set of frequency spectrum components that make it possible to detect regularity in the signal.

FFT analysis is widely used for voice analysis, quality evaluation and fault detection in automobiles, electrical appliances and other products using acoustic and vibration signals.

Fourier Transform is named after the French mathematician Fourier (1768 to 1830) who postulated that any periodic function can be expressed as the sum of the trigonometric function. In 1965, Cooley and Tukey developed an algorithm based upon this concept and, several years later, this became available as an FFT program.

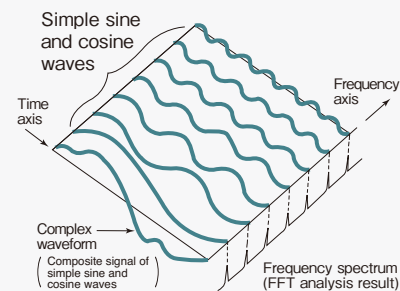

## What is an sound intensity measurement?

This kind of measurement allows sound to be considered as a quantity with a direction component (vector quantity).

The instantaneous sound pressure passing a point in a fluid and the instantaneous particle velocity are multiplied, resulting in the intensity vector (vector quantity). In other words, the sound power ( $W/m^2$ ) that passes the unit area in the unit time is the sound intensity. By measuring the sound intensity, the sound distribution on the measurement plane and the depth of the sound source can be visualized.

## Company Outline



<https://www.rion.co.jp/english/>

RION was founded in 1944, with the aim of developing commercial products based on scientific work carried out at the Kobayasi Institute of Physical Research. Ever since its founding, RION CO., LTD. has upheld the belief that acoustics is a science of great importance to the well-being and welfare of society. RION has continued to introduce products based on this philosophy, aimed squarely at improving quality of life.

A healthy and content society is the vision that guides our activities. RION has three business divisions: "the Medical Instrument Division", "the Environmental Instrument Division", and "the Particle Counter Division". The Medical Instrument Division develops, manufactures, and sells hearing instruments, assistive listening devices, and medical equipment, mainly used in the field of otolaryngology (ear, nose and throat). "The Environmental Instrument Division" develops, manufactures, and sells sound and vibration measuring instruments, including sound level meters, vibration meters and seismometers. "The Particle Counter Division" develops, manufactures, and sells particle counters to measure particles in the air and liquids. RION covers a wide product spectrum while remaining firmly rooted in the science of acoustics. RION products are used by individuals as well as governmental institutions, schools and universities, medical facilities, the service sector, agriculture and fishery industries, and all branches of the manufacturing industry. RION products are not only used domestically but exported to more than 60 countries all over the world. Response has been overwhelmingly positive. RION products are tailored to the requirements and expectations of its customers. This has helped the company maintain a leading position in the industry. RION wants to use its momentum and forward-looking stance to help create a society that is truly easy to live in. The ultimate aim is to provide a safe and gratifying environment for all members of society.

Founded: June 21, 1944

President & CEO: Kiyokatsu Iwahashi

Certifications (in acoustic and vibration measurement field)

ISO 9001: 2015 Certification

ISO 14001: 2015 Certification

Designated manufacturer of special measurement instrument (Sound Level Meters, Vibration Level Meter)



### Logo and Corporate Philosophy

The logo symbolizes confidence in the company itself and the quality of its products. Resembling the ring of a planet, the stylized ring around the "R" expresses awareness of the universe to which our environment belongs and in which RION strives for the betterment and well-being of mankind. The coloring uses RION's traditional blue in two shades of intensity. Cyan signifies energy and vitality, and ultramarine represents intellect and style.

## RION Products

Quality

Ease of use

Reasonable cost

### SOUND AND VIBRATION MEASURING INSTRUMENTS



Sound Level Meter

Vibration Meter

### PARTICLE COUNTER



Airborne Particle Counter

Liquid-borne Particle Counter

### HEARING INSTRUMENT

Rionet Hearing Instruments



BTE Type

Custom-made

### MEDICAL EQUIPMENT



Audiometer



RION has recently concluded a share transfer agreement on the acquisition of the shares of Norsonic for the purpose of strengthening its business in the European and U.S. markets through the acquisition of new sales channels and the enhancement of product ranges with respect to sound measuring instruments. We believe that integrating Norsonic's products, related technologies and sales networks and those of the Group is very effective for developing high value added products and increasing market share. By taking advantage of synergies, the Group will focus its efforts on developing products and services that the market has not seen before.



Norsonic, a company headquartered in Norway, has many users operating chiefly in the Norwegian and overseas architectural acoustic product markets, including the environmental measurement market that primarily consists of European or U.S. governmental organizations and universities. It is one of the world's leading manufacturers, and matches the Company in the development and production of sound measuring instruments such as sound level meters. It enjoys leading market shares in European countries.

Looking at markets associated with sound measurement, environmental monitoring systems, which remotely monitor noises and vibrations generated in a range of places, such as construction sites, factories and roads, and provide customers with data thereof that are stored on the cloud, are becoming mainstay products, especially in Europe and the United States. Norsonic's "NorCloud" environmental monitoring system is a powerful product that responds to these market needs, and it already has a broad range of users in Europe.



**Sound Analyser  
Nor145, 150**



**NorCloud**



**Reference Sound Source  
Nor278**



**Power Amplifier  
Nor282**

## Other services offered by RION Group

### Repair, checking, and calibration (in-house servicing)

Based on standards and procedure guidelines developed in house, we service, adjust, and calibrate products to bring them to the same condition as when shipped new.



Calibration bench

### Inspection certificates for individual products

Inspection certificates for individual products are issued according to RION specifications.

### Measurement

We carry out measurements in the areas of general environmental noise, aircraft noise, sound absorption coefficient, and transmission loss. Other types of sound and vibration measurements can be arranged by consultation.

#### Aircraft noise measurement system



### On-site servicing

For permanently installed equipment or products that cannot be moved, we offer on-site servicing.

### Inspection certificate

After performing servicing and calibration in house, we offer application services for official public certification\* for sound level meters, vibration level meters, and level recorders. We follow through until the official certification is obtained.

\*Performed at the request of the customer

### Maintenance/service contracts

- ① Yearly maintenance contract  
Based on a yearly maintenance contract, we provide periodic checks as well as emergency repair services in case of a problem.
- ② Spot maintenance contract  
This type of contract covers a one-time maintenance procedure based on procedure manuals (specifications).



### ISO compliance documentation

We issue calibration certificates and traceability charts, as well as reference device calibration and inspection certificates. Reference equipment used for calibration is traceability certified according to national standards.

### Custom-made cables

We manufacture cables used for RION measuring instruments to custom lengths. Cost is calculated based on cable type and length.



## Company Outline

# Kobayasi Institute of Physical Research

E-mail [info@kobayasi-riken.or.jp](mailto:info@kobayasi-riken.or.jp)  
URL <https://www.kobayasi-riken.or.jp/>

## Research Facilities

The institute consists of a main building, a test chamber block for architectural acoustics, as well as eight other buildings with combined research and testing facilities. There are four test chambers for wall properties, two for floor properties, six reverberation chambers, one anechoic chamber, four semi-anechoic chambers, and one low-frequency test chamber. The building for the architectural acoustics division is counted among the best research facilities in Japan, making an important contribution to deepening the knowledge of architectural acoustics.

### ● Designated by Ministry of Land, Infrastructure and Transport

Designated evaluation facility according to Architecture Basic Law (Boundary sound insulation structure)

### ● Registered as measurement certification facility

Tokyo Metropolitan, No. 549 (Sound Pressure Level)  
No. 977 (Vibration Acceleration Level)



### Anechoic Room

This specially constructed room is insulated from all outside sound and vibrations. Internal surfaces are covered with 60 cm thick glass fiber blocks for sound absorption, with increasing density in deeper layers. This design ensures excellent absorption characteristics for incident sound from any angle.



### Architectural Acoustics Division Test Chamber Block

This building houses four chambers (two facing pairs) for testing sound insulation of building elements (walls) according to ISO 140-1 and 140-3, as well as two floor test chambers. The two pairs of wall test chambers use different methods for fastening the test object cassette.

The two chambers which serve for floor impact sound testing have a floor base thickness of 200 mm and 150 mm respectively, to allow for testing with different structural parameters.



Interior of test chamber



Foundation Date: August 24, 1940

Chairman: Kohei Yamamoto (Doctor of Engineering)

Location: 3-20-41 Higashi-Motomachi, Kokubunji, Tokyo,  
185-0022 Japan Tel +81-42-321-2841

## History

Based on a public grant by the industrialist Uneo Kobayasi, the concept for the Kobayasi Institute of Physical Research was worked out by Koji Sato, Takuzo Sakai, and others.

In August 1940, permission to establish a non-profit foundation was granted by the Japanese Ministry of Education.

Originally, research was to cover the entire scope of physical science, but eventually the main focus came to be acoustics, which continues to this day.

In 1943, the development of a method to artificially grow Rochelle salt prompted the founding of Kobayashi-Riken Seisakusho Ltd., which is now Rion Corporation.

The institute became a general incorporated foundation in April 2013.

## Organization

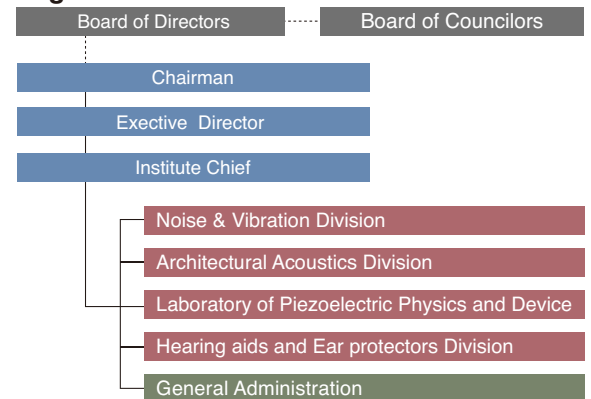

### Scale Model Experiment Chamber

This chamber is used for scale model experiments aimed at clarifying noise propagation characteristics and collecting data for noise prediction. It is a large acoustic chamber insulated from outside sound with a large, flat floor space. Except for the floor, all internal surfaces are treated with sound absorbing materials to prevent reverberation.

# INDEX(Model)

|                 |                        |                 |                |          |                            |               |                |
|-----------------|------------------------|-----------------|----------------|----------|----------------------------|---------------|----------------|
| <b>A</b>        |                        | <b>F</b>        |                | <b>P</b> |                            | <b>U</b>      |                |
| AS-05 Viewer    | 11                     | FI-01A          | 14             | PF-10    | 35                         | UC-57T        | 18, 20         |
| AS-14PA5        | 35                     | FI-02           | 14             | PF-31    | 23                         | UC-59         | 18, 20         |
| AS-15PA5        | 37                     | <b>K</b>        |                | PF-60A   | 23                         | UC-59T        | 18, 20         |
| AS-16PA5        | 37                     | KWS-03          | 19             | PV-03    | 22, 23, 32                 | UG-20         | 27             |
| AS-20PE5        | 35                     | <b>L</b>        |                | PV-08A   | 22, 32                     | UG-21         | 27             |
| AS-30PA5        | 36                     | LF-20           | 23, 32         | PV-10B   | 22, 27                     | UG-33         | 27             |
| AS-31PA5        | 36                     | LR-07           | 21, 33, 45     | PV-10T   | 27                         | UG-50         | 27             |
| AS-60           | 9                      | LS-10C          | 23, 32         | PV-44A   | 22, 32                     | UG-90         | 27             |
| AS-60RT         | 9                      | LS-40C          | 23, 32         | PV-62    | 26                         | UN-14         | 19, 20, 21, 48 |
| AS-60VM         | 25                     | <b>M</b>        |                | PV-63    | 22, 27, 32                 | UV-15         | 30, 32, 33, 48 |
| AS-60VMRT       | 25                     | ME' Scope VES   | 38             | PV-65    | 22, 27, 32                 | UV-16         | 31, 32, 33, 48 |
| AS-70           | 45                     | MS-11A          | 12             | PV-83CW  | 26                         | UV-22         | 21, 30, 32, 33 |
| AS-70GV         | 24                     | <b>N</b>        |                | PV-85    | 22, 32                     | <b>V</b>      |                |
| AS-70Viewer     | 44                     | NA-39A          | 12             | PV-86    | 22, 32                     | VA-12         | 29, 33         |
| <b>B</b>        |                        | NA-39D          | 12             | PV-87    | 22, 32                     | VE-10         | 23             |
| BP-17           | 21, 31, 32, 33         | NA-42           | 19, 20, 21, 48 | PV-90B   | 22, 32                     | VM-54         | 26             |
| BP-21A          | 21, 33                 | NB-14           | 11             | PV-90H   | 22, 32                     | VM-56         | 24             |
| <b>C</b>        |                        | NC-39A          | 18, 31         | PV-90T   | 22, 32                     | VM-57         | 25             |
| CAT-CMP-BR      | 41                     | NC-72B          | 19, 20, 21     | PV-91C   | 22, 32                     | VM-63C        | 28             |
| CAT-CMP-MTA     | 40                     | NC-72-S26       | 20             | PV-91CH  | 22, 32                     | VM-82A        | 28, 33         |
| CAT-CMP-ORD     | 41                     | NC-72-S27       | 20             | PV-93    | 22, 32                     | VM-83A        | 31, 32, 33, 48 |
| CAT-CMP-REF     | 41                     | NC-75           | 11, 19, 20, 21 | PV-94    | 22, 32                     | VP-26A        | 23, 32         |
| CAT-CMP-SQ      | 41                     | NC-75-022       | 20             | PV-95    | 22, 32                     | VP-40         | 23, 32         |
| CAT-Report      | 39                     | NC-75-S11       | 20             | PV-97    | 22, 32                     | VP-42         | 23, 32         |
| CAT-SA02-AR     | 39                     | NC-98E          | 21, 33         | PV-97C   | 22, 26, 32                 | VP-51A        | 32, 48         |
| CAT-SA02-CMP01  | 40                     | NC-99A          | 21, 31, 33     | PV-97I   | 22, 26, 32                 | VP-51B        | 32             |
| CAT-SA02-CPWL   | 39                     | NE-21P          | 21             | <b>R</b> |                            | VP-51C        | 32             |
| CAT-SA02-HT     | 39                     | NH-04B          | 18, 20         | R-EMS    | 12                         | VP-51I        | 32             |
| CAT-SA02-Order  | 38                     | NH-05B          | 18, 20         | RIONOTE  | 20, 21, 32, 42, 43, 48     | VP-51J        | 32             |
| CAT-SA02-Pro    | 38                     | NH-06A          | 18, 20         | <b>S</b> |                            | VP-51L        | 32             |
| CAT-SA02-SQ     | 38                     | NH-12A          | 18, 20         | SA-02A4  | 20, 21, 32, 33, 34, 44, 48 | VP-51LB       | 32             |
| CAT-SA02-TH     | 39                     | NH-17           | 18, 20         | SA-02M   | 20, 21, 32, 33, 34, 44, 48 | VP-51LC       | 32             |
| CAT-SA32        | 39                     | NH-17A          | 18, 20         | SA-A1B2  | 42                         | VP-51W        | 32             |
| CAT-SAA1-ORDTRK | 43                     | NH-22A          | 18, 20         | SA-A1B4  | 42                         | VP-51WL       | 32             |
| CAT-UV22-MS     | 33                     | NH-22AT         | 20             | SA-A1WD  | 42                         | VP-52C        | 22, 32         |
| CAT-WAVE        | 45                     | NL-28           | 10             | SC-AC043 | 16                         | VP-53S        | 22             |
| CC-24           | 21, 33                 | NL-43           | 8, 21, 48      | SI-31I   | 37                         | VP-53T        | 22             |
| CC-42R          | 21, 33                 | NL-53           | 8, 21, 48      | SI-33I   | 37                         | VP-54D        | 24             |
| CC-43CT         | 21                     | NL-63           | 8, 21, 48      | SX-A1CMP | 43                         | VP-54L        | 24             |
| CC-43S          | 21                     | Nor145          | 6, 7           | SX-A1FT  | 43                         | VP-80         | 26             |
| CF-27           | 31                     | Nor150          | 6, 7           | SX-A1RT  | 43                         | VT-06         | 46             |
| <b>D</b>        |                        | Nor265A         | 15             | SX-A1VA  | 43                         | VX-54FT       | 26             |
| DA-21           | 20, 21, 32, 33, 44, 48 | Nor278          | 15             | SX-A1WR  | 43                         | VX-54WB1      | 26             |
| <b>E</b>        |                        | Nor282          | 15             | <b>T</b> |                            | VX-54WH       | 26             |
| EC-02S          | 32                     | Nor283          | 15             | TWS-01   | 19                         | VX-54WS       | 26             |
| EC-02SB         | 32                     | Nor850          | 14             | <b>U</b> |                            | VX-56RT       | 24             |
| EC-02SD         | 32, 48                 | Nor850-MF1      | 14             | UA-10    | 20                         | VX-56WR       | 24             |
| EC-02SE         | 32, 48                 | Nor1051         | 7              | UA-12    | 20                         | VX-57EX       | 25             |
| EC-03001        | 48                     | Nor1026         | 7              | UA-20    | 20                         | VX-57RT       | 25             |
| EC-04           | 20, 48                 | Nor1256         | 19             | UA-31    | 20                         | VX-57WR       | 25             |
| EC-04A          | 20, 48                 | NorCloud        | 7              | UA-90    | 48                         | <b>W</b>      |                |
| EC-04B          | 20, 48                 | NorVirtual      | 7              | UC-27    | 18, 20                     | WS-01         | 19, 20         |
| EC-04C          | 20, 48                 | NX-43EX         | 9              | UC-29    | 18, 20                     | WS-05         | 19, 20         |
| EC-04D          | 20, 48                 | NX-43FT         | 9              | UC-30    | 18, 20                     | WS-10         | 19, 20         |
| EC-04E          | 20, 48                 | NX-43RT         | 9              | UC-31    | 18, 20                     | WS-15         | 19             |
| EC-04S          | 48                     | NX-43WR         | 9              | UC-33P   | 18, 20                     | WS15006       | 19             |
| EC-40A          | 32                     | NX-50           | 27             | UC-34P   | 18, 20                     | WS-16         | 19             |
| EC-40B          | 32                     | NX-63RT         | 9              | UC-35P   | 18, 20                     | <b>Y</b>      |                |
| EC-40C          | 32                     | <b>Others</b>   |                | UC-52    | 18, 20                     | YI-01         | 14             |
| EC-40D          | 32                     | 5WKR4030        | 21, 33         | UC-52T   | 18, 20                     | <b>Others</b> |                |
| EC-54S          | 48                     | <b>5WKR4030</b> |                | UC-54    | 18, 20                     | 5WKR4030      | 21, 33         |
| EC-54SA         | 48                     |                 |                | UC-57    | 18, 20                     |               |                |
| EC-54SB         | 48                     |                 |                |          |                            |               |                |
| EC-90A          | 20, 21, 33, 48         |                 |                |          |                            |               |                |
| EC-90B          | 20, 21, 33, 48         |                 |                |          |                            |               |                |

# INDEX(Name)

|   |                        |   |                            |   |                |
|---|------------------------|---|----------------------------|---|----------------|
| <b>Alphanumeric</b>                           |                        | <b>I</b>  |                            | <b>S</b>  |                |
| 1/2 inch microphone adapter .....             | 20                     | Impact Ball .....                               | 14                         | Seat Accelerometer .....                          | 26             |
| 1/2 inch Nose Cone .....                      | 20                     | Impact Force Measuring Device .....             | 35                         | Self-learning Evaluation System .....             | 40             |
| 1/3 Octave Real-time Analysis Program .....   | 25                     | Impedance Head .....                            | 23                         | Servo Accelerometer .....                         | 23, 32         |
| 1/3 Octave Band Analysis Program .....        | 24                     | Impedance Tube .....                            | 17                         | Servo Accelerometer Power Supply .....            | 23, 32         |
| 1/4 inch microphone adapter .....             | 20                     | Interface Cable .....                           | 21, 33                     | Single channel Sound Analyser .....               | 6              |
| 2-Channel Charge Amplifier .....              | 31, 32, 48             | Interface Unit .....                            | 21, 30, 32, 33             | Sound and Vibration Measurement System .....      | 38             |
| 3-Axis Vibration Meter .....                  | 26                     | <b>J</b>  |                            | Sound Arrival Direction Sensor .....              | 12             |
| 3-ch preamplifier .....                       | 26                     | Judgement Program .....                         | 43                         | Sound Calibrator .....                            | 19, 20, 21     |
| 4 channel Data Recorder .....                 | 20, 21, 32, 33, 44, 48 | Junction Box .....                              | 27                         | Sound Intensity Measurement                       |                |
| 4-20 mA Isolation Unit .....                  | 27                     | <b>L</b>  |                            | Software .....                                    | 37             |
| 4-Channel Signal Analyzer .....               | 34, 48                 | L-bracket .....                                 | 24                         | Sound Intensity Probe .....                       | 37             |
| 7P Microphone Extension Cable .....           | 48                     | Level Recorder .....                            | 21, 33, 45                 | Sound Level Meter (class 1) .....                 | 6, 8, 21       |
| <b>A</b>                                      |                        | Loss Factor Measurement Software .....          | 35                         | Sound Level Meter (class 2) .....                 | 8, 10, 21      |
| AC Adapter .....                              | 21, 31, 33             | <b>M</b>  |                            | Sound Level Meter Cable .....                     | 48             |
| Accelerometer Cable .....                     | 48                     | Magnet Attachment .....                         | 22                         | Sound Level Meter Unit .....                      | 19, 20, 21, 48 |
| AC/DC Output splitter cable .....             | 21                     | Marine Vibration Card .....                     | 26                         | Sound Power Level Measurement Software            |                |
| Acoustic Camera .....                         | 16                     | Measuring Amplifier .....                       | 19, 20                     | for Construction Machinery .....                  | 39             |
| Acoustical Volumeter .....                    | 47                     | Measurement System .....                        | 14                         | Sound Power Level Measurement Software            |                |
| Airborne Noise/Floor Impact Noise             |                        | Misophone Boom .....                            | 15                         | for Hemi-anechoic Room .....                      | 36             |
| Insulation Measurement Software .....         | 35                     | Microphone Holder .....                         | 48                         | Sound Power Level Measurement Software            |                |
| Aircraft noise and flights analysis .....     | 13                     | Microphone Preamplifier .....                   | 20                         | for Reverberation Room .....                      | 36             |
| Anechoic Box (Compact Type) .....             | 17                     | Microphone With Preamplifier .....              | 18                         | Sound-Proof Chamber .....                         | 17             |
| Anechoic Room .....                           | 17                     | Mode Analysis Software .....                    | 38                         | Sound Quality Evaluation Software .....           | 38             |
| Array Type Visualization Software .....       | 39                     | Multi-Channel Signal                            |                            | Sound Source Location Software .....              | 37             |
| <b>B</b>                                      |                        | Analzer .....                                   | 20, 21, 32, 32, 34, 44, 48 | PSSR .....  | 12             |
| Battery Pack .....                            | 21, 33                 | <b>N</b>  |                            | Standard Cable .....                              | 32, 48         |
| Battery Unit .....                            | 21, 31, 32, 33         | Noise Dosimeter .....                           | 11                         | <b>T</b>  |                |
| Bearing Vibration Evaluation System .....     | 41                     | NorCloud .....                                  | 7                          | Tapping Machine Light Floor Impact Sound          |                |
| BNC Adapter .....                             | 22, 32                 | <b>O</b>  |                            | Generator .....                                   | 14             |
| BNC-BNC Cable .....                           | 21, 33                 | Octave, 1/3 Octave Real-time                    |                            | Threshold Evaluation System .....                 | 40             |
| BNC-BNC Coaxial Cable .....                   | 21, 33, 48             | Analysis Program .....                          | 9                          | Throughput Disk .....                             | 39             |
| BNC-mini plug Cable .....                     | 21, 33                 | Order Tracking Program .....                    | 43                         | Tracking Analysis Software .....                  | 38             |
| <b>C</b>                                      |                        | Outdoor Microphone .....                        | 12                         | Triaxial Accelerometer .....                      | 22, 25         |
| Calibration Exciter .....                     | 23                     | <b>P</b>  |                            | Tri-axial Groundborne Vibration Meter .....       | 24             |
| Charge Converter .....                        | 23, 32                 | Piezoelectric Accelerometer .....               | 22, 27, 32                 | Triaxial Simultaneous Measurement                 |                |
| Comparator Output / Trigger input cable ..... | 21                     | Pistonphone .....                               | 19, 20, 21                 | Intensity Probe .....                             | 37             |
| Condenser Microphone .....                    | 18, 20                 | Pocketable Vibration Meter .....                | 28                         | Tri-axial Standard Cable .....                    | 32             |
| <b>D</b>                                      |                        | Portable Multi-function Measuring               |                            | <b>U</b>  |                |
| Data Management Software for Environmental    |                        | System .....                                    | 20, 21, 32, 33, 42, 48     | Ultra-compact Accelerometer Cable .....           | 32             |
| Measurement .....                             | 9, 25                  | Power Amplifier .....                           | 15                         | User Filter .....                                 | 27             |
| Data Recorder .....                           | 21, 32, 33             | Preamplifier .....                              | 18, 20, 27, 32             | UV-22 Sound and Vibration Monitoring System ..... | 30             |
| DIN Plate .....                               | 24                     | PV-08 Cable .....                               | 32                         | <b>V</b>  |                |
| Dual channel Sound Analyser .....             | 6                      | PV-97 Tri-axial Accelerometer Cable .....       | 32                         | Vibration Analysis Program .....                  | 43             |
| Dodecahedron Loudspeaker .....                | 15                     | PV-97I Tri-axial Accelerometer Cable .....      | 32                         | Vibration Analyzer .....                          | 29, 33         |
| Dual Windscreen for Wind Turbine Noise        |                        | <b>R</b>  |                            | Vibration Level Meter .....                       | 25, 33, 48     |
| Measurement .....                             | 19                     | Rack Mounting Base .....                        | 31                         | Vibration Level Meter / Vibration Meter           |                |
| <b>E</b>                                      |                        | Rack Mount Panel .....                          | 27                         | Accelerometer Cable .....                         | 48             |
| Environmental information Web Service .....   | 13                     | Real-time noise and flights map in public ..... | 13                         | Vibration Meter Preamplifier .....                | 23             |
| Extended Function Program .....               | 9, 25                  | Real-time Sound Quality Evaluation System       |                            | Vibration Meter Unit .....                        | 30, 32, 33, 48 |
| Extension Cable .....                         | 20, 32, 48             | for Noise Detection .....                       | 41                         | Vibration Monitor .....                           | 27             |
| <b>F</b>                                      |                        | Reception and management of complaint .....     | 13                         | Viewer Software .....                             | 44             |
| FFT Analysis Card (VX-54FT) .....             | 26                     | Reference Level Comparison Method Evaluation    |                            | Viscometer .....                                  | 46             |
| FFT Analysis Program system .....             | 9                      | System .....                                    | 41                         | <b>W</b>  |                |
| FFT & Order Tracking Evaluation System .....  | 41                     | Reference Piezoelectric Accelerometer .....     | 23                         | Waveform Analysis Software .....                  | 45             |
| Flexible Rod .....                            | 20                     | Reference Sound Source .....                    | 15                         | Waveform Analysis Software for                    |                |
| Force sensor .....                            | 23                     | R-EMS .....                                     | 12                         | Groundborne Vibration .....                       | 24             |
| <b>G</b>                                      |                        | Report Creation Support Tool .....              | 39                         | Waveform Data Manipulation Software .....         | 39             |
| General-Purpose Vibration                     |                        | RIONOTE 2 channel Amplifier .....               | 42                         | Waveform Recording Program .....                  | 9, 24, 25      |
| Meter .....                                   | 28, 31, 32, 33, 48     | RIONOTE 4 channel Amplifier .....               | 42                         | Whole Body Vibration Card .....                   | 26             |
| <b>H</b>                                      |                        | RIONOTE Main Control Unit .....                 | 42                         | Windscreen .....                                  | 19, 20         |
| Hand-Arm Vibration Card .....                 | 26                     | RIONOTE Software for FFT .....                  | 43                         | <b>W</b>  |                |
| Hand-arm Vibration Measurement Software ..... | 39                     | RIONOTE Software for 1/1 and 1/3 Octaves .....  | 43                         | Waveform Analysis Software .....                  | 45             |
| Heat-resistant Cable .....                    | 32                     | RIONOTE Software for Waveform Recording .....   | 43                         | Waveform Analysis Software for                    |                |
| Heavy Floor Impact Source .....               | 14                     | RIONOTE Wireless Dock .....                     | 42                         | Groundborne Vibration .....                       | 24             |
|   |                        | RS-232C Serial I/O Cable .....                  | 21, 33                     | Waveform Data Manipulation Software .....         | 39             |

# Sound and Vibration



<https://rion-sv.com/>

<https://www.norsonic.com/>



**JCSS**  
JCSS 0197

RION CO., LTD. is recognized by the JCSS which uses ISO/IEC 17025 as an accreditation standard and bases its accreditation scheme on ISO/IEC 17011. JCSS is operated by the accreditation body (IA Japan) which is a signatory to the Asia Pacific Accreditation Cooperation (APAC) as well as the International Laboratory Accreditation Cooperation (ILAC). The Quality Assurance Section of RION CO., LTD. is an international MRA compliant JCSS operator with the accreditation number JCSS 0197.

\* Windows is a trademark of Microsoft Corporation. \* Specifications subject to change without notice.

Distributed by:

 **RION CO., LTD.**

3-20-41, Higashimotomachi, Kokubunji, Tokyo 185-8533, Japan  
Tel: +81-42-359-7888 Fax: +81-42-359-7442